

# inter— teknik

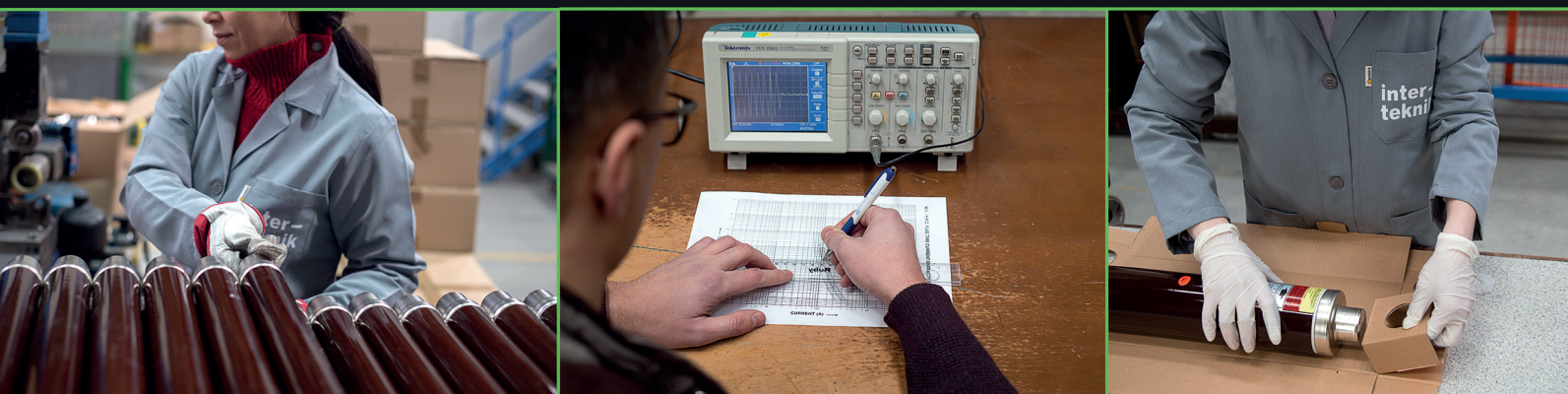

## HIGH VOLTAGE FUSES

• CURRENT LIMITING TYPE • HIGH BREAKING CAPACITY • BACK-UP CLASS



## HIGH VOLTAGE FUSES

- ***CURRENT LIMITING TYPE***
- ***HIGH BREAKING CAPACITY***
- ***BACK-UP CLASS***

Standarts: TS EN 60282-1, VDE 0670/4, DIN 43625



INTER – TEKNİK fuse links are automatic, selectively acting medium voltage switching devices which will protect your transformers, motors, overhead lines, voltage transformers, capacitor banks and installations safely from the thermal and dynamic effects of short circuits within the voltage range of 6-36 kV.

Our experience from 1969 to date, together with extreme care in production, conscious quality control and emphasis on continuous development is the basis of the superior quality of INTER – TEKNİK fuses.

Although there are various types of h.v. fuses, the more reliable and economic CURRENT LIMITING TYPES are mostly preferred in many countries as well as ours. This type works quietly in a completely closed environment. While it functions, no flame or gas overflows outside the system. Therefore no filter, flame cell or special ventilation system is necessary.

The types of fuses with high breaking capacity are used for the short circuit protection of m.v. installations. When they are placed in front of transformers, capacitors, motors, cable outlets or voltage transformers, they protect against the heat or other bad effects of shortcircuit by quick circuit breaking capabilities.

Fuses are the most effective and economic ways of protection against short circuits in m.v. installations.

Fuses are not suitable devices for protection against overload. They work safely only over the  $I_{min}$  value. Namely it does not operate safely within the range of  $I_n$  (rated current value) and  $I_{min}$  value, and in some cases the fuses may be damaged. Depending on the quality of the melting line used and the construction of the fuse,  $I_{min}$  shows changes.

Naturally the expansion of the safe operating area for a fuse is a great advantage. For this reason  $I_{min}$  should be as small as possible.

If loading between  $I_n$  rated current and  $I_{min}$  is a must and cannot be prevented, then it is recommended to use load break switches with thermal protective fuses. In that case, before the extreme heat produced in the fuse reaches the tolerance level of the electro porcelain tube of the fuse, the thermic system works to loosen the striker pin which in turn switches off the loadbreak switch in three phases, thus minimizing the risk



## CONSTRUCTION



Against short-circuits,  
fuses provide the  
most effective and  
affordable solution



The principle component of the fuse link insert is a starshaped rod. The **pure silver** wire or band is wound around the starshaped rod, thus forming completely similar small cells all along the body. The lengths and cross section of the silver in each cell is completely the same. Many partial arcs form all along the melting line and the thermal heat is evenly distributed in the fuse body thus attaining a higher breaking capacity. The tubes are definitely durable to extreme heat, non inflammable and insulated. More over, especially the outdoor type fuses are durable to atmospheric changes, corrosion, salts, acids and alkali gases. They do not absorb water or moisture. In case the fuse is blown, the body provides insulation. Therefore it must provide the needed insulation level rain or shine. To attain these properties, the ideal material to be used is **electro porcelain**.

To be durable enough to resist the high pressure and heat that will form, the porcelain tubes should be at the least, conforming with the C120 – C130 IEC 672 standards. Metal caps on both ends are made of electrolytic copper of 1 – 1,2 mm. thickness and are nickel or silver plated (4 – 6 microns) against oxidation. The caps are tightly pressed onto the porcelain tubes using silicone seal. Metal pieces in the inner body are manufactured from electrolytic copper. Depending on the In value, they are either silver coated or copper striped of oil. To obtain perfect current conductivity and fuse characteristics the silver wires and bands are welded onto the metal body by point-welding source. The inner body and outer body are also attached by point welding source.

The mechanic strength and water insulation of our fuses are attained by mounting the metal and optical glass caps on both sides, sealing with high heat resistant silicone and special pressing methods.

## TYPES

The sizes of all our fuse types conform with TS EN 60282-1, DIN43625, and are suitable for indoor and outdoor use.

### OPTICAL INDICATOR (TYPE: .../OPT)

The fuses with optical indicators, types H220 and H221, have a mechanism showing that the fuse is blown. When the fuse is blown, a small red cap falls into the transparent capsule at the end of the tube.



FUSE WITH OPTICAL INDICATOR

### STRIKER PIN (TYPE: .../ACT) TS EN 60282-1, Table XII – (Medium)

When a fuse is blown a pin is strongly pushed out. Hence, you can see the blown fuse and also automatically initiate another system (e.g. : a switch, notification of an alarm system).



FUSE WITH STRIKER PIN

### STRIKE PIN FORCE

There are three options:

- A) 100 – 120 N
- B) 80 N
- C) 50 N

The preference should be stated while ordering. If it's necessary to open a switch mechanically, then the choices A or B are advisable.

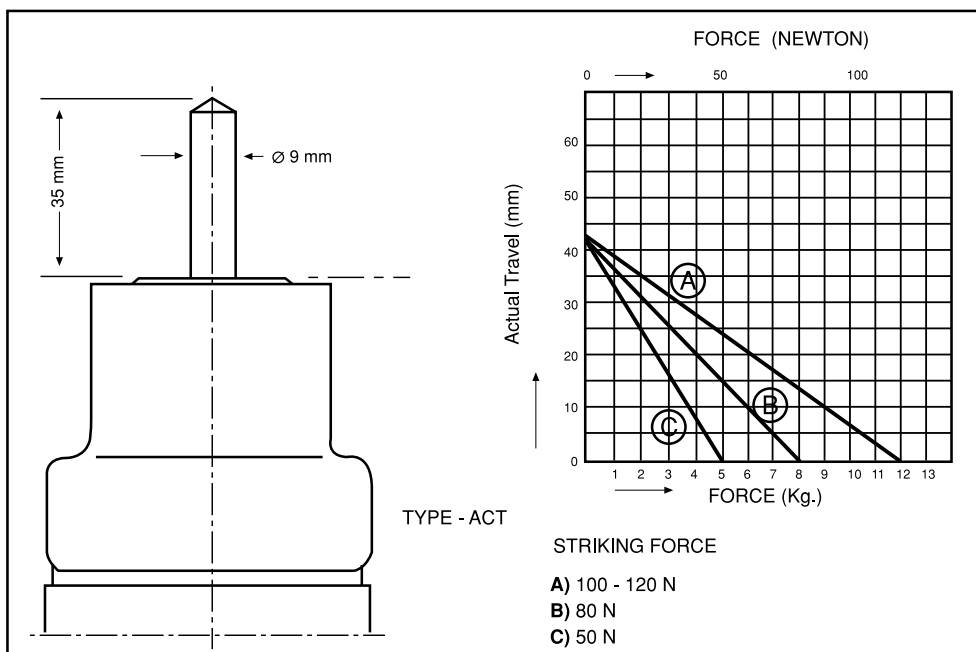

## **THERMAL PROTECTION (current limiting type, back-up class)**

The operation of medium voltage fuses with thermal protection is determined by minimum breaking current ( $I_{min}$ ). These fuses only work safely over the  $I_{min}$  value. Namely, between the values  $I_n$  (rated current) and  $I_{min}$  a safe operation cannot be guaranteed.

The over loading of fuses in between these values may cause explosion and big damage.

The melting element of the fuse will melt in just one or a few small pieces and the arc produced here will continue to travel within the circuit, leading to extreme thermal forces.

In order to eliminate this problem, our fuses type H220 ACT and type H221 ACT, have a thermal protection system. In this special design, the fuses have a striker device inside the fuse link which is released before the temperature reaches a value endangering the thermal strength of the porcelain tube, and initiates opening of all poles by the help of a switch – disconnecter.

Fuses with the thermal protection system should be used in combination with a switch. When used in combination with automatic breaking switch or especially with SF6 gas insulated “Ring Main Unit” pannels, fuses with thermal protection system should be preferred.

Please do not hesitate to contact us for more information on thermal protection.

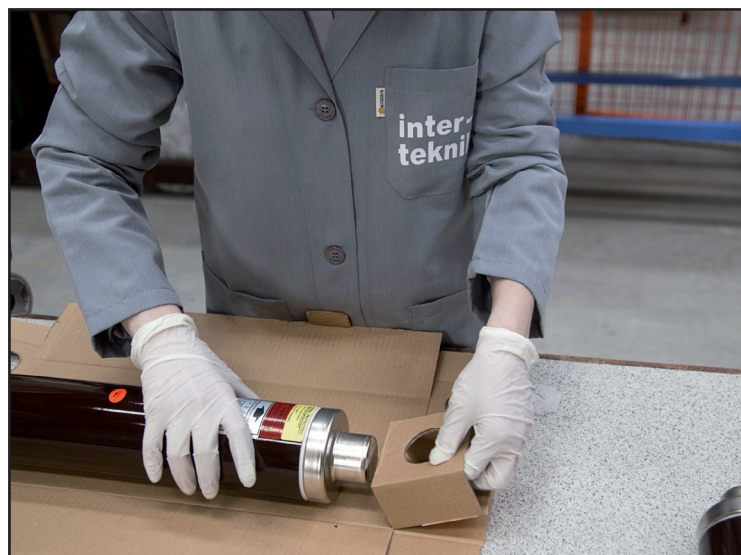

The risk caused by the extreme thermal forces may be avoided with the use of thermal protection feature.

## SHORT CIRCUIT CURRENT LIMITATIONS

Our high-voltage high-breaking-capacity fuse links open the circuit during the current rise in the first loop of short-circuit current. They are thus current-limiting.

The figure below shows the progress of a short-circuit operation. Without a fuse in the circuit, the short-circuit current would rise as the prospective current  $I_k$  shown as a broken line.

However, the current-limiting action of the fuse-link permits the melting current  $I_s$  to rise only to the cut-off value  $I_D$  (full line). The current decreases during the arcing time  $t_L$  with increasing arc length and is finally broken in the area of a voltage zero passage.

The current-limiting action of the fuse-links relieves the apparatus and parts of the system of thermal and dynamic stresses. It is clear that the application of current-limiting fuse-links is particularly advantageous in older installations which have not been designed for the increasing short-circuit levels of the system.

The value of the cut-off current is influenced by the design of the fuse-link. It further depends on the rated current and the instant on the voltage wave at which the short-circuit occurs.

- $I_S$  Melting current
- $I_D$  Cut-off current
- $I_{k(t)}$  Prospective short-circuit current (fuse replaced by metallic link)
- $I_p$  Impulse short-circuit current
- $T_s$  Pre-arcing time
- $T_L$  Arcing time

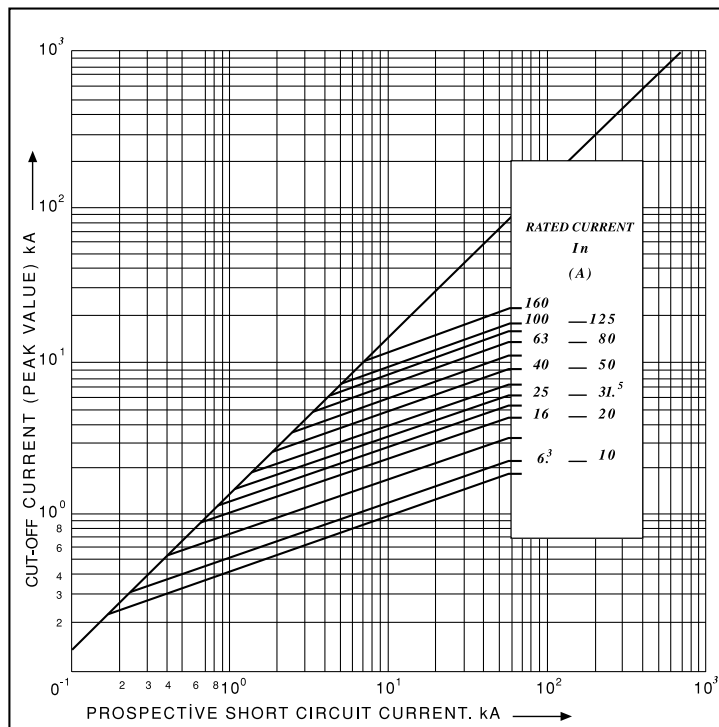
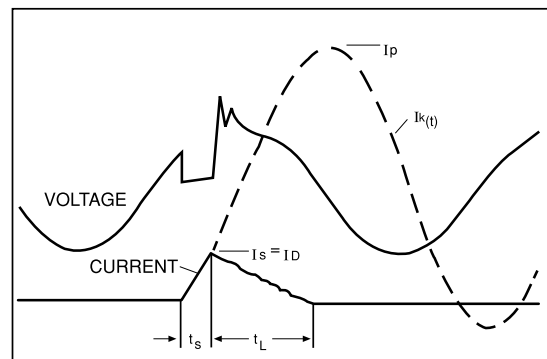

The cut-off current of our h.v. h.b.c. fuse links, which can be taken from the diagram, are a function of the prospective short-circuit current (r.m.s. value of the symmetrical component) and of the rated current.

The prospective short-circuit current is expressed by the r.m.s. value of the symmetrical component of the current which would flow at the location of installation if the fuse were replaced by a solid link.

The cut-off currents determined from the diagram are the maximum values which might occur for a given r.m.s. value of the symmetrical component of the prospective short-circuit current with any degree of asymmetry and the highest rate of current rise. Actual values are thus, as a rule, less than the values determined here.

## RATED BREAKING CURRENT CAPACITY

The rated breaking current capacity depends on the inner structure of the fuse. The special construction of the fuse link insert ensures that short pre-arcing and arcing times are obtained on operation and that multiple partial arcs are formed. Accordingly the amount of heat generated in the fuse link is relatively small and uniformly divided over the whole length of the fuse elements. These factors provide the increase in the rated current breaking capacity of a fuse. (Please check the rated breaking current values of INTER –TEKNIK fuses on the back over)

## DANGEROUS EXTREME VOLTAGES

When the short circuit current is broken, the voltage will jump. Not to let any damage happen to devices in the installation due to this voltage jump, peak value is limited as  $2 \cdot U_N \cdot (\sqrt{2})$  in the TS and VDE norms. The advantage of using these fuses to protect your transformers, cable outlets and voltage transformers is obvious.

## MINIMUM OPERATING VOLTAGE

- In cases where higher breaking capacity is needed or,
- When an installation with low operating voltage is going to be renewed to a higher operating voltage unit (e.g.: because the voltage will be 30 kV, the old installation with an operating voltage of 10 kV will be renewed as 30 kV series) a higher  $U_N$  valued fuse might be used. If the operating voltage is small in regard to the  $U_N$  value of the fuse, the voltage jump while the circuit breaks may be extremely  $\frac{1}{2}$ , meaning that in an operating voltage of 10 kV, a fuse with  $U_N = 20$  kV can be safely used.

For this reason, keeping in mind that the breaking capacity should be suitable to the operating voltage, while giving your orders you should also state the D dimension of the fuse you have selected. Example: In an installation where operational voltage is 10 kV, a fuse of D=442mm can be used (equivalent to a fuse  $U_N=24$  kV)

## POWER DISSIPATION

The heat produced in the fuse should be released to the atmosphere. In indoor areas and insulated panels, heat is a vital factor effecting the nominal values of the devices.

Approximate power dissipation of the fuse may be calculated as  $(R \cdot I^2 \cdot K)$ ; the fuses inner resistance (R value at temperature 20°C) increases due to heating. The K factor indicating this increase is about 1,4 – 2 at the  $I_n$  value. For current values lower than  $I_n$ , this factor takes a value of 1,1 – 1,4.

## TIME CURRENT CHARACTERISTICS OF THE MEDIUM VOLTAGE HIGH BREAKING CAPACITY FUSES

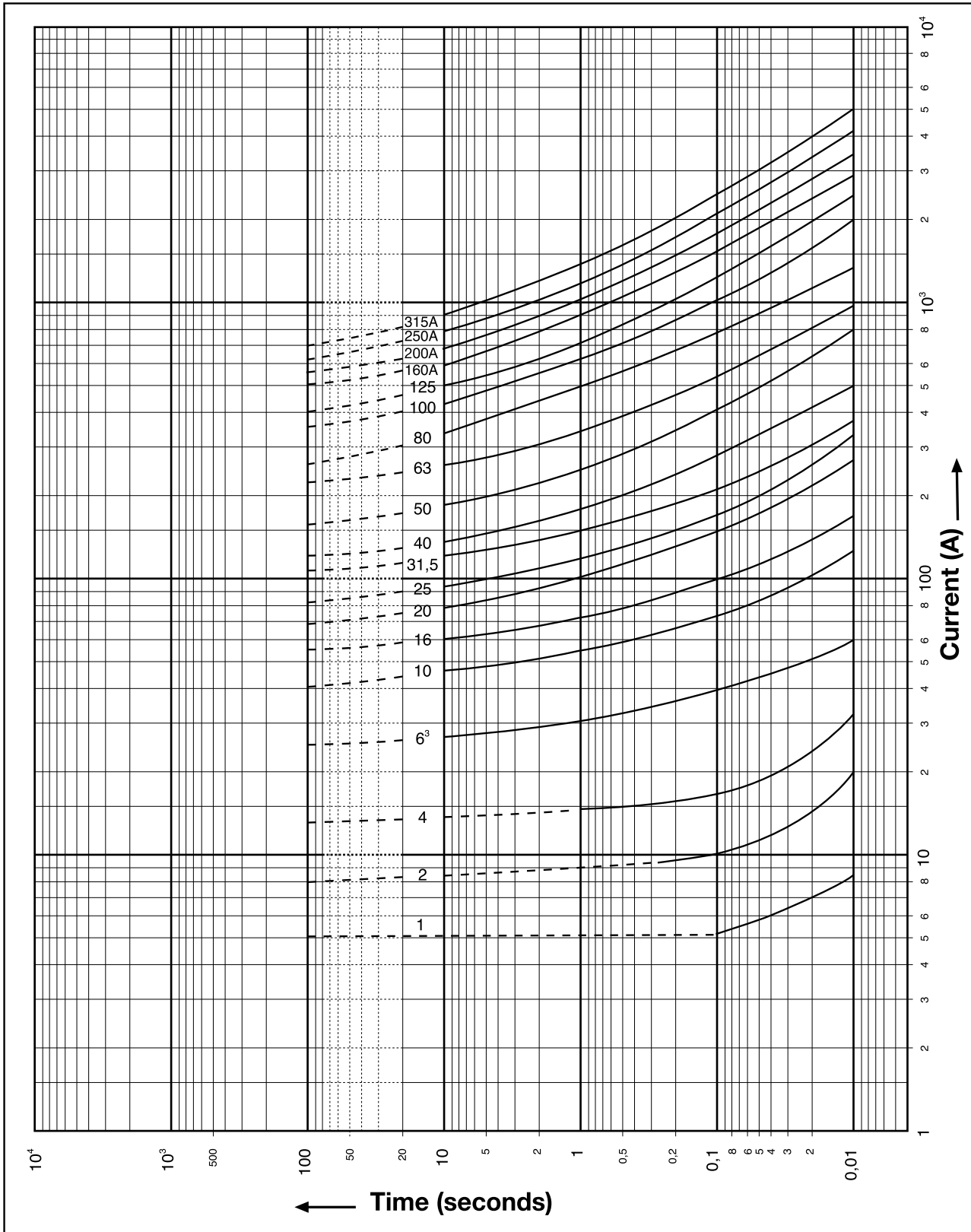



## SELECTIONS

### RATED VOLTAGE

Must be properly selected in accordance with the operational voltage.

### RATED BREAKING CURRENT

Proper fuse selection according to the short circuit load of the network is important. In some special occasions, if necessary, a fuse of a higher voltage group may be selected or two fuses may be connected in serial, thus obtaining a higher rated breaking current capacity.

### RATED CURRENT

This value denotes the naming of the fuse. Essentially the selection of the fuse according to the purpose and the place of use is very important. Heat is one of the most important factors. For example in the protection of a transformer, if a fuse of  $I_n=6$  A is suitable outdoors, when the same transformer is used in a completely closed indoor area, then a fuse  $I_n=10$  A may be necessary. In extreme cases where higher current values are necessary, two fuses with the same value connected parallel can be used. But as the two fuses standing side by side will give heat to each other, a specific tolerance level should be set.

### DERATING FACTOR

The rated current is the current which a fuse link can carry continuously without altering the time/current characteristic curve. At higher ambient temperatures as well as higher power losses generated by fuses of very high rated currents, it is necessary to pay special attention to derating factors.

Depending on usage conditions and due to the overheating of the fuse body, it is advisable to reevaluate the choice of fuse rating and use a fuse with a greater  $I_n$  value.

In fuses that operate with melting fuse elements, the heat of the fuse body is the main factor that effects the functioning of the fuse. As it functions, the heat produced in the fuse should be transferred to the atmosphere in an effective way. If the body of a used. For example, under normal conditions a fuse  $I_n=40$  A might be suitable for the protection of a transformer, but if because of environmental factors the fuse heats excessively, then a fuse of  $I_n=50$  or  $63$  A should be used.

As the plants of our day are huge and growing in size, they require fuses with very high  $I_n$  values for their protection. Meanwhile, as the  $I_n$  value of fuses increase, due to physical limitations of material and production methods, it becomes very difficult to keep the heat of the fuse at normal temperatures. Therefore, especially under these circumstances special attention should be given to the DERATING FACTOR.

Due to their high starting currents, in the protection of electrical appliances such as motors, transformers or capacitors, fuses with in  $I_n$  values should be selected. In other words, under normal operating conditions the current passing through the fuse will be approximately half, under 25% overload it will be about 75% of the  $I_n$  value of the fuse. Generally the nominal current of the fuse should be 2 or 3 times larger then that of the normal circuit current. It is important to keep this fact in mind.

This means the fuses will warm less. As you evaluate, special attention should be given to this issue. For this reason, on the labels of these fuses both current values are indicated. For example "250 RC 160" means:

- the nominal current of the fuse  $I_n=250$  A. (the starting current is taken into consideration)
- the current value of the continuous current through the circuit RC (rated current) is 160 A.

## MOTOR PROTECTION IEC 60644

The first important criteria in fuse selection is the value and the duration of the INRUSH current of the motor. The fuse should stand this inrush current. In selecting the fuse from the time-current curves, the tolerance on current rates given in the standards should not be neglected ( $\pm 20\%$  on current value). The second criteria is the frequency of starting the motor which can lead to the aging of the fuse, which in turn might result in changes in the characteristics of the fuse. Depending on the frequency of the period of starting, the  $I_n$  value of the fuse may be uprated. In selecting your fuse, please keep in mind following: Usually fuse+switch combinations are used for motor protection. If one of the fuses blow due to a fault, the striker pin initiates the switch to break the current in three phases.

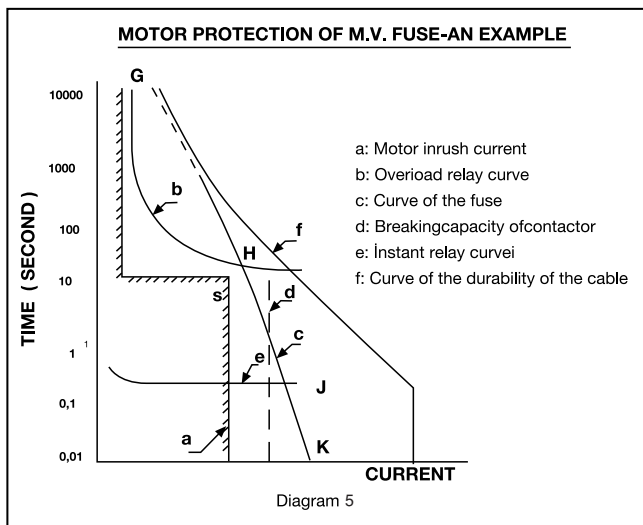

- The breaking capacity of the fuse should be greater than the short circuit load of the establishment.
- The  $I_n$  value of the fuse should be greater than the nominal power and overload value of the motor. Derating should be done according to the medium in which the fuse will be used, meaning the  $I_n$  value of the fuse should be increased accordingly.
- The  $I_n$  value should be decided upon with an acceptable margin so that the fuse does not blow during starting current period.
- Depending on the number of starting/shutting of the motor, there will be material fatigue.  $I_n$  value should be increased accordingly.
- The minimum breaking current ( $I_{min}$ ) value of the fuse should be smaller than the value of point H (see diagram 5).

For the coordination between the fuse and the protection relay of the switch, and for all the above listed issues please use the diagram.

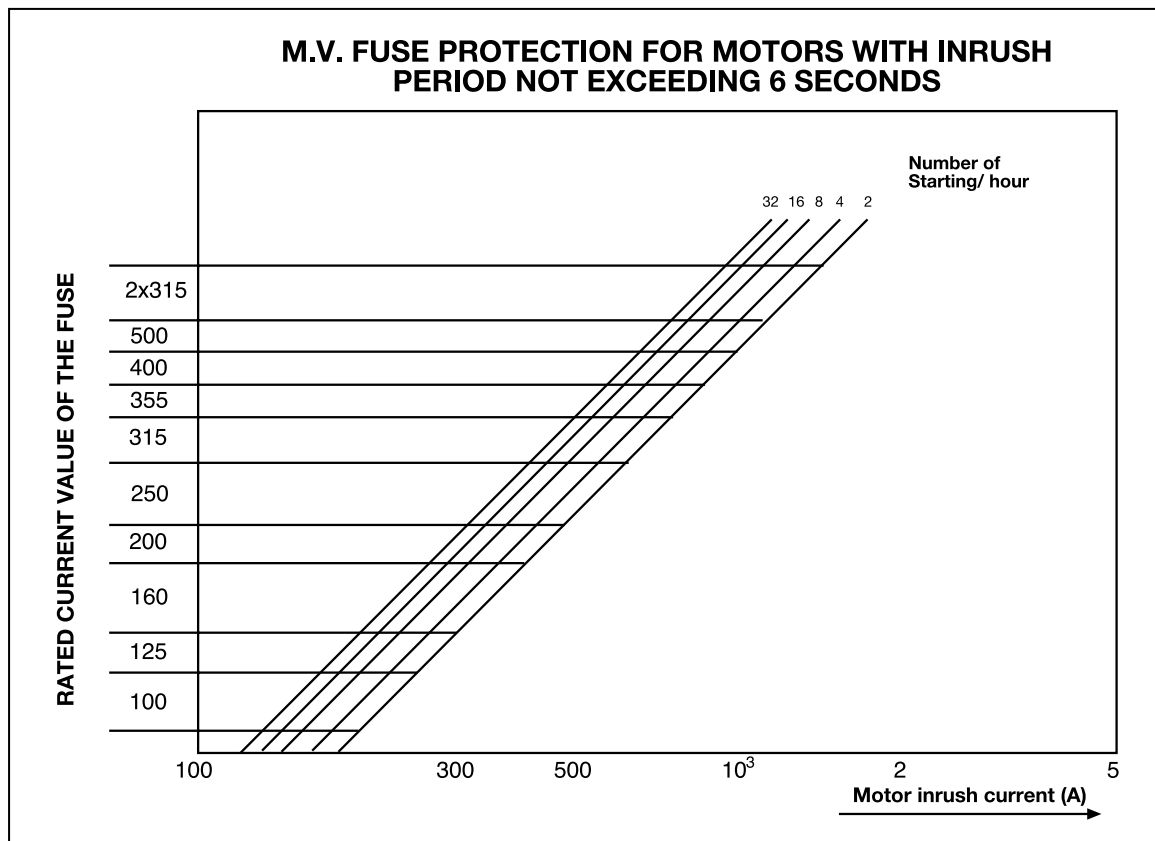

**MV FUSE PROTECTION FOR MOTORS WITH INRUSH PERIOD NOT EXCEEDING 15 SECONDS**

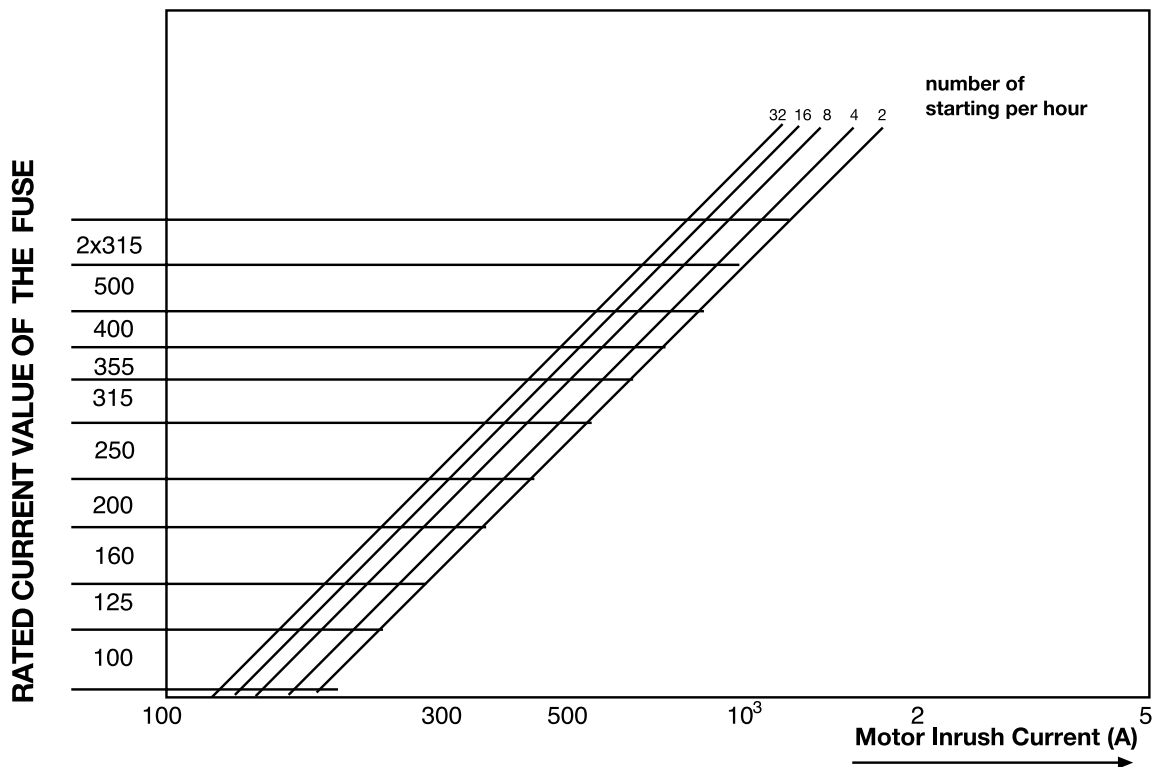

**MV FUSE PROTECTION FOR MOTORS WITH INRUSH PERIOD NOT EXCEEDING 30 SECONDS**

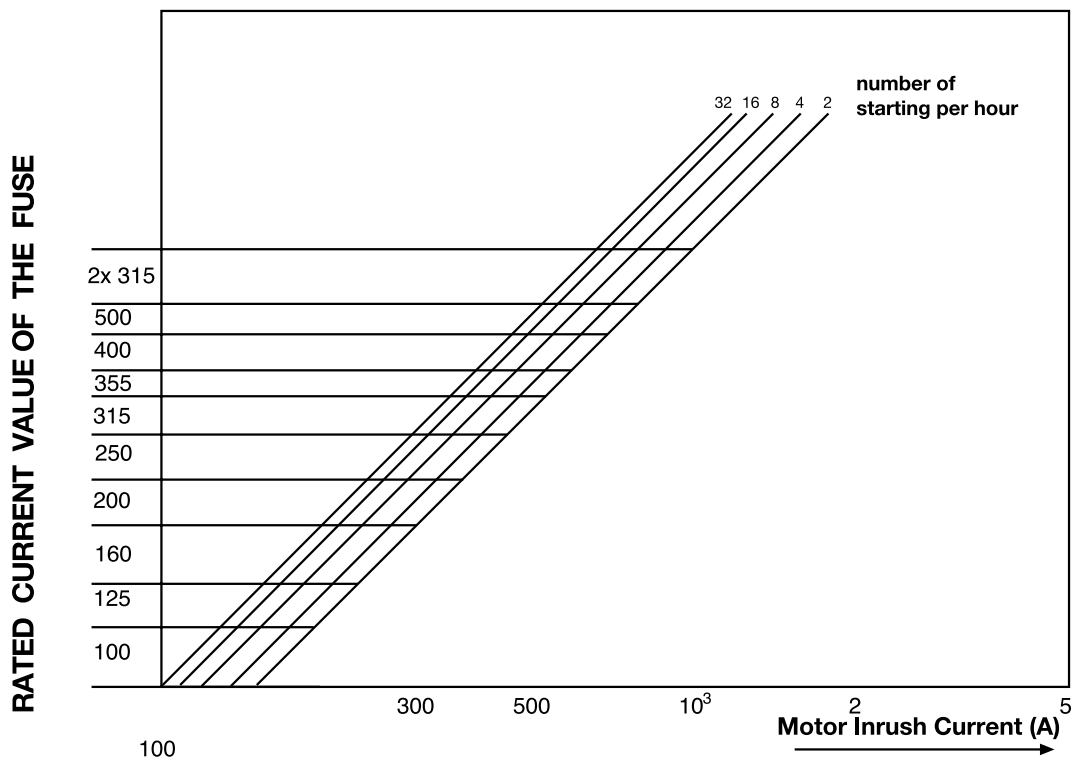

## FUSE PROTECTION OF TRANSFORMERS IEC 60787

All tests and practices show that, when chosen correctly, current limiting h.v. fuses effectively protect transformers by breaking fault currents.

Various criteria have to be observed in selecting h.v.h.b.c. fuse-links for the short circuit protection of transformers. Here are some of them:

- 1- The rated current of the h.v.h.b.c. fuse-link must not be less than a certain value so as to protect operation of the fuse-link from the transformer inrush current on switching on.
- 2- The rated current of the fuse-link must be low enough so that the value of the current which might happen during a short-circuit on the low voltage side of the transformer will not be less than I<sub>min</sub> value of the fuse. This means that the fuse will perform its breaking safely.
- 3- The rated current of the medium-voltage fuse link must be sufficiently high to permit the overloading of the transformer and assure selectivity between the fuses on the low voltage side.
- 4- The rated current of the h.v.h.b.c. fuse-link must be as low as possible so that the fuse can break the current quickly when a fault occurs in the transformer coils and assure the selectivity between the fuse and relay at the start of the mv supply feeder.

Taking the above mentioned points into account, selecting the h.v.h.b.c. fuse links in accordance with the tables below is recommended.

### H.V. and L.V. FUSE SELECTING TABLES FOR THE PROTECTION OF DISTRIBUTION TRANSFORMERS

Trans. Rated Power (kVA)	Transformer Rated Current		M.V. Fuse Rated Current		L.V. Fuse Rated Current	
	prim. (A)	sec. (A)	min. (A)	max. (A)	min. (A)	max. (A)
	Rated Voltage U <sub>1N</sub> = 6/7,2 kV U <sub>2N</sub> = 400V					
25	2,4	36	6,3	6,3	31,5	40
50	4,8	72	10	16	63	80
75	7,2	108	16	25	100	125
100	9,6	144	20	31,5	125	160
125	12,0	180	25	40	160	200
160	15,4	231	31,5	50	200	250
200	19,2	290	40	63	250	315
250	24,0	360	50	80	315	400
315	30,3	455	63	100	400	500
400	38,5	576	80	125	500	630
500	48,1	720	100	160	630	720
630	60,6	910	125	200	800	900
800	77,0	1160	160	200	1000	1200
1000	96,2	1440	200	200	1200	-

Trans. Rated Power (kVA)	Transformer Rated Current		M.V. Fuse Rated Current		L.V. Fuse Rated Current	
	prim. (A)	sec. (A)	min. (A)	max. (A)	min. (A)	max. (A)
	Rated Voltage U <sub>1N</sub> = 10/12 kV U <sub>2N</sub> = 400V					
25	1,45	36	4	6,3	31,5	40
50	2,9	72	6,3	16	63	80
75	4,3	108	10	16	100	125
100	5,8	144	16	25	125	160
125	7,2	180	16	25	160	200
160	9,2	231	20	31,5	200	250
200	11,5	290	25	31,5	250	315
250	14,4	360	31,5	50	315	400
315	18,2	455	40	63	400	500
400	23,1	576	50	80	500	630
500	28,9	720	63	100	630	720
630	36,4	910	80	125	800	900
800	46,2	1160	100	125	1000	1200
1000	57,7	1440	125	160	1200	-

Trans. Rated Power (kVA)	Rated Voltage U <sub>1N</sub> = 15/17,5 kV U <sub>2N</sub> = 400V						Rated Voltage U <sub>1N</sub> = 20/24 kV U <sub>2N</sub> = 400V						Rated Voltage U <sub>1N</sub> = 30/36 kV U <sub>2N</sub> = 400V					
	Transformer Rated Current		M.V. Fuse Rated Current		L.V. Fuse Rated Current		Transformer Rated Current		M.V. Fuse Rated Current		L.V. Fuse Rated Current		Transformer Rated Current		M.V. Fuse Rated Current		L.V. Fuse Rated Current	
	prim. (A)	sec. (A)	min. (A)	max. (A)	min. (A)	max. (A)	prim. (A)	sec. (A)	min. (A)	max. (A)	min. (A)	max. (A)	prim. (A)	sec. (A)	min. (A)	max. (A)	min. (A)	max. (A)
25	0,95	36	4	6,3	31,5	40	0,7	36	4	6,3	31,5	40	0,5	36	2	6,3	31,5	40
50	1,9	72	6,3	10	63	80	1,4	72	6,3	6,3	63	80	1,0	72	4	6,3	63	80
75	3	108	10	10	100	125	2,2	108	6,3	6,3	100	125	1,5	108	6,3	6,3	100	125
100	4	144	10	16	125	160	2,9	144	10	10	125	160	1,9	144	6,3	6,3	125	160
125	4,8	180	16	20	160	200	3,6	180	10	16	160	200	2,4	180	6,3	10	160	200
160	6,1	231	16	25	200	250	4,6	231	16	20	200	250	3,1	231	10	16	200	250
200	7,7	290	20	25	250	315	5,8	290	16	20	250	315	3,8	290	10	16	250	315
250	9,6	360	25	31,5	315	400	7,2	360	20	25	315	400	4,8	360	16	20	315	400
315	12,1	455	25	31,5	400	500	9,1	455	20	25	400	500	6,1	455	16	25	400	500
400	15,3	576	25	40	500	630	11,5	576	25	40	500	630	7,7	576	16	25	500	630
500	19,7	720	31,5	50	630	720	14,4	720	31,5	50	630	720	9,6	720	25	31,5	630	720
630	24,9	910	40	63	800	900	18,2	910	40	63	800	900	12,1	910	31,5	40	800	900
800	30,8	1160	63	80	1000	1200	23,1	1160	50	63	1000	1200	15,4	1160	40	50	1000	1200
1000	38,6	1440	80	100	1200	-	28,9	1440	63	80	1200	-	19,2	1440	40	50	1200	-
1250	48,1	1800	100	100	-	-	36,1	1800	80	80	-	-	24	1800	50	63	-	-
1600	61,6	2304	125	125	-	-	46,2	2304	100	100	-	-	30,7	2304	63	80	-	-
2000	77,0	2880	160	160	-	-	57,8	2880	125	125	-	-	38,5	2880	2 x 50	-	-	-

## FUSE PROTECTION OF CAPACITOR BANKS

The existence of numerous types of electrical facilities and unknown circuit parameters usually complicates fuse selection. When selecting, keep in mind the following criteria:

- The  $I_n$  value of the fuse should be high enough to withstand the continuous maximum load current and the allowable harmonic content.
- The  $I_n$  value of the fuse should be able to tolerate the inrush value of the condenser bank.
- Voltage increases caused by temporary situations should not be neglected and for security purposes, a higher current class fuse should be selected.
- As for practical information, the  $I_n$  value of the fuse should not be lower than 1,6 – 2 times that of the condenser's full load current value.

## WIRE AND LINE PROTECTION

It should not be forgotten that wires and lines will be exposed to overloading from time to time. This situation may cause overloads between the  $I_n$  value and  $I_{min}$  value of the fuse, eventually causing extreme heating and damage. For this reason the fuse should be selected according to the maximum load that the cable or line can carry.

## OTHER POINTS

- It is not correct to use a fuse that has been dropped or exposed to any sort of impact without testing it.
- In a three – phase installation, unless you are definitely sure that only the blown fuse was exposed to a faulty current, all three must be replaced, because the fuses that are not blown also might have reached a point very close to functioning and their characteristics might have changed.
- As a precaution, the blown fuse should be changed 5 – 10 minutes after it has blown.

## VOLTAGE TRANSFORMER PROTECTION

Because of the low capacity of voltage transformers, h.v. fuses cannot protect the voltage transformer from their own default currents effectively. More often, they are used to separate the defected voltage transformer from the system. The principle in choosing the fuse is to use a fuse big enough to endure the inrush voltage of the transformer. This means that the fuse should be at the most  $I_n=1-2$  A. The very thin melting line used in the fuses with small  $I_n$  values may lead to a "corona" effect. Therefore, the fuse should definitely be used as far away from earthed metal parts as possible.

## THINGS TO INDICATE WHILE ORDERING

Type	: H220 – H221
Indicator	: OPT (Optical) or ACT (striker pin)
If ACT, the force of the striker pin	: F=50 N, F=80 N, F=120 N
Thermal protection	: TRM
Rated voltage ( $U_n$ ) kV	: from the table
Length (D) mm	: from the table
Rated current ( $I_n$ ) A	: from the table

Example 1-	H220/ACT	F=80 N	Example 2-	H221/OPT	
	$U_n=36$ kV	D=537 mm		$U_n=12$ kV	D=442 mm
	$I_n=40$ A	$I_1= 31,5$ kA		$I_n= 160$ A	$I_1=63$ kA

## POTENTIAL TRANSFORMER PROTECTION FUSE

5,5 kV - 36 kV . Type: GTS  
(without indicator, indoor type)

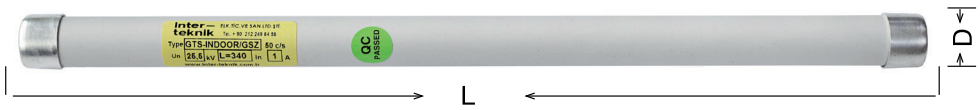

Rated voltage Un (kV)	Rated current In (Amp)	L mm	D mm	Breaking capacity I1 (kA.)	Approx. (Weight) kg.
5,5	1	127	20	63	0.090
	2				
7,2 / 8,25	1	190	20	63	0.130
	2				
7,2/12/15,5	1	254	20	63	0.175
	2				
15,5/25,5	1	340	20	63	0.230
	2				
* 36	1	400	36,5	40	0.935
	2				

\* Optional: if demanded, the fuse can be produced with indicator.

Note: please indicate Un, In and L values while you are giving orders.

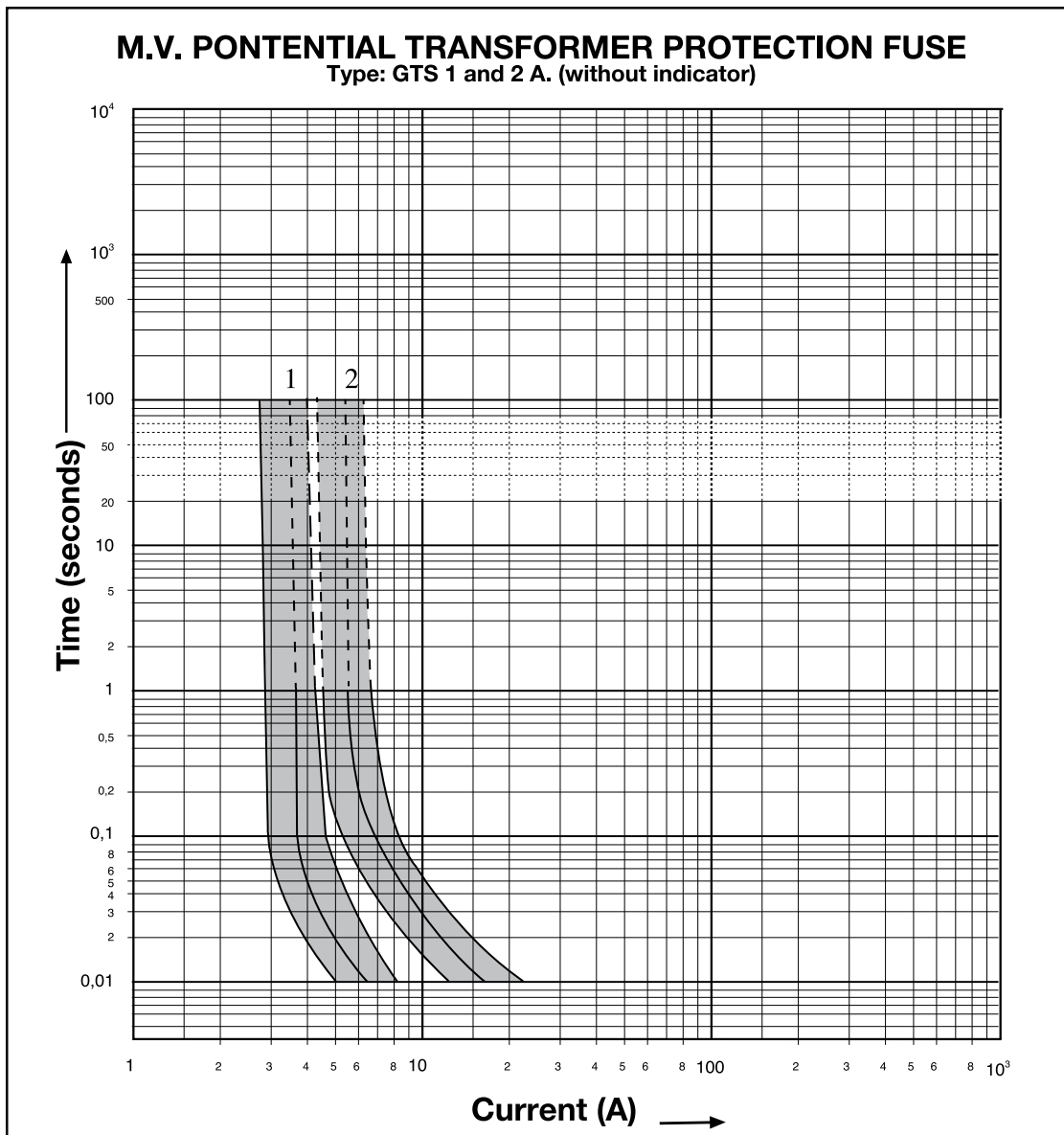

## OVERVIEW OF STANDARD AND NON-STANDARD DIMENSIONS OF H.V. FUSE DIMENSIONS

Rated voltage	Body length(mm)	Rated Current (A)																			
		1	2	4	6.3	10	16	20	25	31.5	40	50	63	80	100	125	160	200	250	315	
36kV	537	537 x Ø53										537 x Ø68	537 x Ø86								
36kV	442	442 x Ø53					442 x Ø68					442 x Ø86									
36kV	367	367 x Ø53					367 x Ø68					367 x Ø86									
36kV	292	292 x Ø53			292 x Ø68			292 x Ø86													
24kV	442	442 x Ø53										442 x Ø68					442 x Ø86				
24kV	537	442 x Ø53										442 x Ø68					442 x Ø86				
24kV	367	367 x Ø53					367 x Ø68					367 x Ø86									
24kV	292	292 x Ø53					292 x Ø68					292 x Ø86									
24kV	192	192 x Ø53			192 x Ø68			192 x Ø86													
17.5kV	367	367 x Ø53										367 x Ø68					367 x Ø86				
17.5kV	537	537 x Ø53										537 x Ø68					537 x Ø86				
17.5kV	442	442 x Ø53										442 x Ø68					442 x Ø86				
17.5kV	292	292 x Ø53					292 x Ø68					292 x Ø86									
17.5kV	192	192 x Ø53			192 x Ø68			192 x Ø86													
12kV	292	292 x Ø53										292 x Ø68					292 x Ø86				
12kV	537	537 x Ø53										537 x Ø68					537 x Ø86				
12kV	442	442 x Ø53										442 x Ø68					442 x Ø86				
12kV	367	367 x Ø53										367 x Ø68					367 x Ø86				
12kV	192	192 x Ø53					192 x Ø68					192 x Ø86									
7.2kV	192	192 x Ø53										192 x Ø68					192 x Ø86				
7.2kV	537	537 x Ø53										537 x Ø68					537 x Ø86				
7.2kV	442	442 x Ø53										442 x Ø68					442 x Ø86				
7.2kV	367	367 x Ø53										367 x Ø68					367 x Ø86				
7.2kV	292	292 x Ø53										292 x Ø68					292 x Ø86				

# inter— teknik

For detailed information please visit our website. Meanwhile, we're glad to offer our technical expertise whenever required, so you are most welcome to contact us for your technical inquiries.

[www.inter-teknik.com.tr](http://www.inter-teknik.com.tr)

## Head Office

Kemankeş Cad. Fransız Geçidi  
İş Merkezi No:53 Kat:1 C Blok D:16  
Karaköy, Beyoğlu / İstanbul-TR  
T +90 212 249 84 58 / 244 32 49

## Factory

Şekerpınar Mah. Marmara Geri  
DönüşümcülerYapı Koop. Defne Sok.  
No:3 Çayırova / Kocaeli-TR  
T +90 262 658 93 11