

Brass plate
CZ0223-H03 M25×1.5
Brass plate
4036/6
CZ0220-A03-M25
Cable diameter: Φ8-17

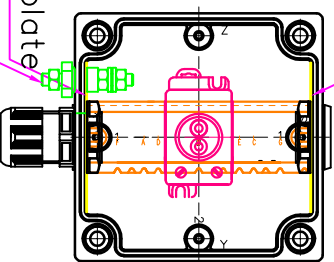

Ex-mark:EX db IIc T6 Gb/ Ex tb IIIC T80°C Db
Intended use: Can be used in zone 1 and zone 2, zone 21 and zone 22
Ambient temperature:-40°C ≤T_a≤40°C
Degree of protection: IP66
Rated voltage: 250V
Rated current: 10A
Material of enclosure: GRP Size:122*122*096mm Come with one board front mounting rail type explosion proof illumination switch, with the label "I-II", "1NC+1NO Come with one M25 plastic cable gland and a 8018/11X
(71*68*0.5MM) brass sheet at the bottom.
Come with one M25 plastic stopping plug and a 8018/11X(71*68*0.5MM) brass sheet at the top.
Come with one M6 Internal and external earthing screw.

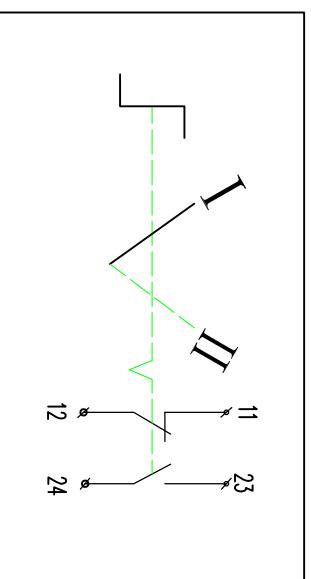

Customer			Approve sign				
Service			Date				
Designer	GU0	Date	2019.12.03				
Audit	YE	Recheck					
			Unit: mm				
Product Name		Explosion-proof terminal box					
Product Code		CZ1242/002L-T1/XA03/S-H03					
Quantity		15 SETS					
Page 1 of 1		DWG#		20191203G001			



面板式安装防爆电器

Explosion-proof electrical appliances for panel mounting

CZ1242

A

描述:

CZ1242系列全塑防爆控制箱原型号为CZ0242。

全塑防爆控制箱的外壳材料外壳采用耐冲击的抗静电玻璃纤维增强聚脂材料制成，用于恶劣的工作危险区域，具有高抗腐、防水、防尘特性，可满足化学、石化和海上工业的使用要求。

CZ1242/1、2、3系列全塑防爆控制箱有三种外壳尺寸供选择，内置1—9个板前导轨型防爆元件，箱盖设计成凸面结构。该系列产品已设计成标准化型号供选择。

CZ1242/001—092系列全塑防爆控制箱有八种外壳尺寸供选择，内置1—56个板前导轨型防爆元件，箱盖设计成平面结构，可根据元件数量选择对应的壳体。

Descriptions:

Full plastic explosion-proof control box CZ1242 series, instead of the former code CZ0242.

The enclosure of full plastic explosion-proof control box is made of anti-static glass fibre reinforced polyester with resistance of impact and static. It can be applied in industrial hazardous areas featuring in high anti-corrosion, water-protection and dust-protection to meet any requirements from chemical, petrochemical and marine industries.

For full plastic explosion-proof control box CZ1242/1,2,3 series, there are three enclosure sizes for options, can be mounted 1-9 pieces rail mounting Ex components inside. The cover is designed to convex. These series products are now standardized.

For full plastic explosion-proof control box CZ1242/001-092 series, there are eight enclosure sizes for options, can be mounted 1-56 pieces rail mounting Ex components inside. The cover is designed to flat structure. Different enclosure sizes can be selected as different quantities of components.

以上二种系列产品除壁式安装外，另可提供立式脚盘附件，作于立柱式操作之用。也可根据用户要求设计定制。

- 可选用塑制、金属电缆密封套
- 安装简易
- 高防护等级 IP66
- IECEx 国际认证、ATEX 欧盟认证

For above two series products, besides of wall mounting, vertical tray accessories are available and also it can be customized.

- Moulded plastic or metal cable glands can be selected.
- Easy installation.
- High degree of protection IP66.
- IECEx International Approval, ATEX European union certification.

1 区和 2 区
Zone 1 and zone 2
21 区和 22 区
Zone 21 and zone 22



方案 Method:

低箱体：元件布局一层 Low box: component layout one layer

图样 Illustration	规格 Specifications	长×宽×高 (mm) Length×width×height
	CZ1242/001	122 × 122 × 96
	CZ1242/011	122 × 170 × 96
	CZ1242/031	134 × 220 × 96
	CZ1242/051	160 × 275 × 96
	CZ1242/071	234 × 352 × 96
	CZ1242/081	352 × 352 × 96

高箱体：元件布局二层 High box: component layout two layer

图样 Illustration	规格 Specifications	长×宽×高 (mm) Length×width×height
	CZ1242/032	134 × 220 × 141
	CZ1242/052	160 × 275 × 161
	CZ1242/072	234 × 352 × 161
	CZ1242/082	352 × 352 × 161
	CZ1242/092	352 × 706 × 161

示意图 Diagram:

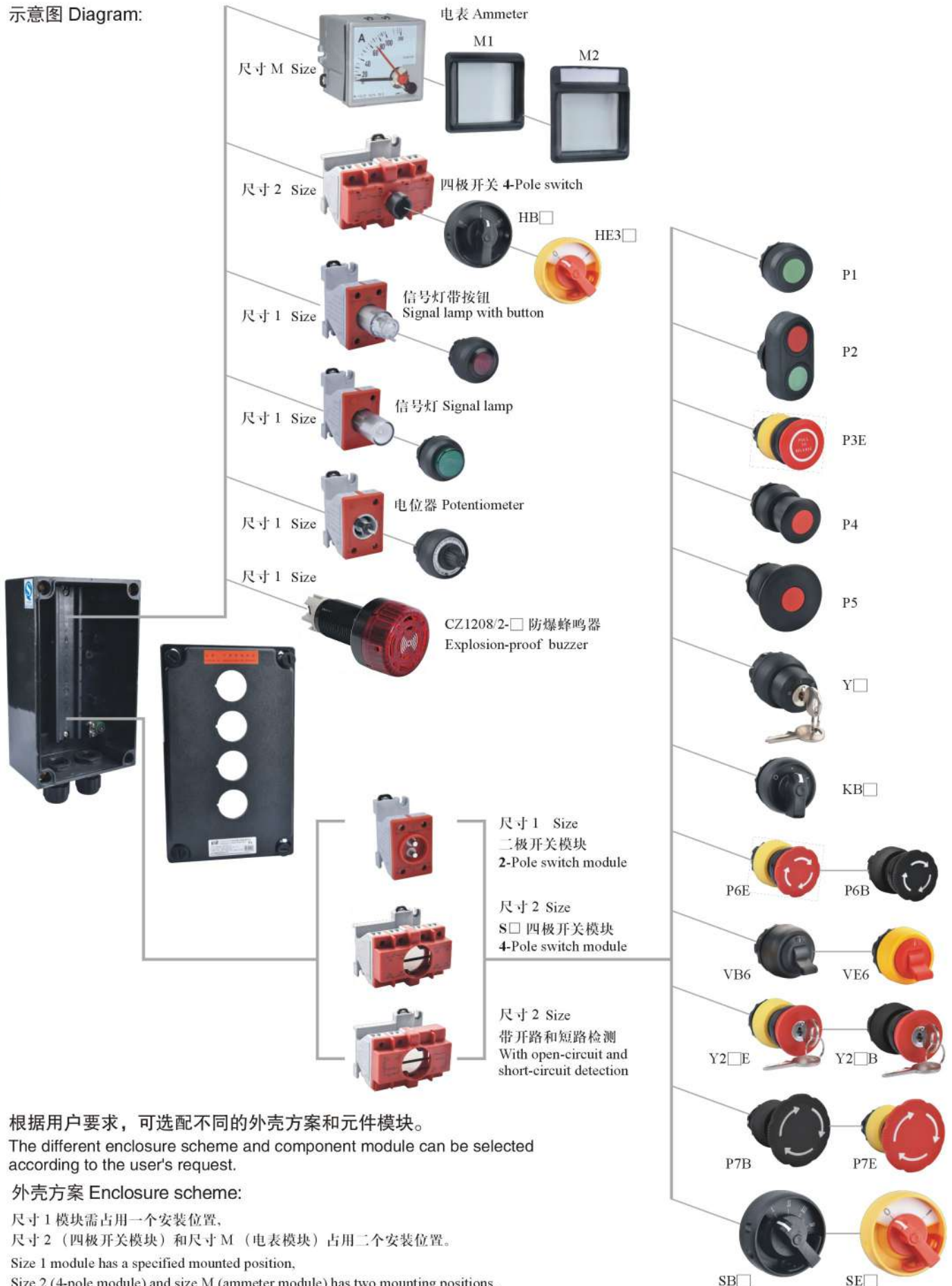

根据用户要求，可选配不同的外壳方案和元件模块。
The different enclosure scheme and component module can be selected according to the user's request.

外壳方案 Enclosure scheme:

尺寸 1 模块需占用一个安装位置，
尺寸 2（四极开关模块）和尺寸 M（电表模块）占用二个安装位置。
Size 1 module has a specified mounted position,
Size 2 (4-pole module) and size M (ammeter module) has two mounting positions.



4032/□ 立式脚盘
Vertical foot tray



配4032/□立式脚盘
Match 4032/□ vertical foot tray together



配4032/□带不锈钢防雨罩立式脚盘
Match 4032/□ vertical foot tray with
stainless steel water-proof cover

主要数据 Main technical data:

认证 Certification	防爆标志 Ex mark	符合标准 Meet the standard
China: CE18.5062X	Ex d e ia mb II C T6/T5/T4 Gb Ex tD A21 IP66 T80°C/T95°C/T130°C	GB3836 GB12476
IECEX: IECEX CML17.0044X	Ex db eb ia mb II C T6/T5/T4 Gb Ex tb IIIC T80°C/T95°C/T130°C Db	IEC60079
ATEX: CML17ATEX3104X	Ex II 2 GD Ex db eb ia mb II C T6/T5/T4 Gb Ex tb IIIC T80°C/T95°C/T130°C Db	EN60079

适用范围: 用于 1 区和 2 区, 用于 21 区和 22 区

 使用环境温度: $-40^{\circ}\text{C} \leq \text{Ta} \leq +40^{\circ}\text{C}/+55^{\circ}\text{C}$
 $-55^{\circ}\text{C} \leq \text{Ta} \leq +40^{\circ}\text{C}/+55^{\circ}\text{C}$ (可选)

防护等级: IP66 / IP65

额定电压: up to 690V

额定电流: up to 180A

 元件端子: $2 \times 2.5\text{mm}^2$

 PE 端子: 4mm^2

外壳材料: GRP(抗静电玻璃纤维增强聚脂 SMC)

 电缆入口: 壁式: $1 \times \text{M}25$, 电缆外径 $\Phi 8 \sim 17\text{mm}$
 $1 \times \text{M}32$, 电缆外径 $\Phi 12 \sim 21\text{mm}$

立式安装 (安装附件详见 A/74 页)

Intended use: Can be used in zone 1 and zone 2

Can be used in zone 21 and zone 22

 Ambient temperature: $-40^{\circ}\text{C} \leq \text{Ta} \leq +40^{\circ}\text{C}/+55^{\circ}\text{C}$
 $-55^{\circ}\text{C} \leq \text{Ta} \leq +40^{\circ}\text{C}/+55^{\circ}\text{C}$ (Optional)

Degree of protection: IP66 / IP65

Rated voltage: up to 690V

Rated current: up to 180A

 Component terminal: $2 \times 2.5\text{mm}^2$





 PE terminals: 4mm^2

Material of enclosure: GRP(anti-static glass fibre reinforced polyester SMC)

 Cable entry: wall type: $1 \times \text{M}25$, Cable outside diameter: $\Phi 8 \sim 17\text{mm}$
 $1 \times \text{M}32$, Cable outside diameter: $\Phi 12 \sim 21\text{mm}$

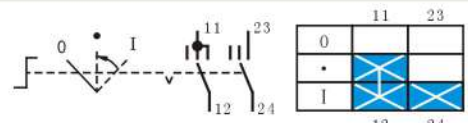
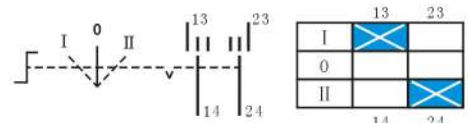
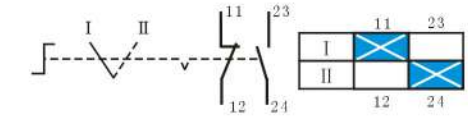
Vertical mounted (mounting accessory see A/74)

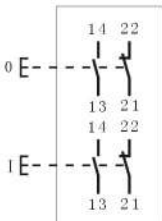
订购规格 Order specifications:
CZ1242/1 全塑防爆控制箱(操作柱) Full plastic Explosion-proof control box (operation post)

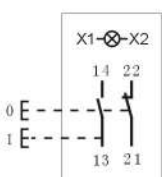
图样 Illustration	描述 Description	重量(kg) Weight	订购号 Order No.
		1.150	CZ1242/1□-0101-2
		1.150	CZ1242/1□-0102-2
		1.150	CZ1242/1□-0103-2
	 <p>2 个按钮, 每个带 1NO+1NC, 包括标识牌“0, I, START, STOP”</p> <p>Two buttons, each with 1NO+1NC, Including label “0, I, START, STOP”</p>	1.120	CZ1242/1□-0204-2
	 <p>● 红 LR Red LR ● 绿 LG Green LG ● 黄 LY Yellow LY ● 兰 LB Blue LB ○ 白 LW White LW</p> <p>1 个信号灯 20V - 250V AC/DC 1 个双按钮 1NO+1NC 包括标识牌“0, I, START, STOP”</p> <p>One signal lamp 20V - 250V AC/DC One double button 1NO+1NC Including label “0, I, START, STOP”</p>	1.130	CZ1242/1□-0205-2 CZ1242/1□-0206-2 CZ1242/1□-0207-2 CZ1242/1□-0208-2 CZ1242/1□-0209-2

CZ1242/1 全塑防爆控制箱(操作柱) Full plastic Explosion-proof control box (operation post)





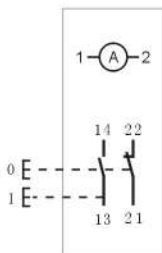
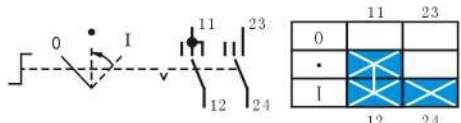

图样 Illustration	描述 Description	重量(kg) Weight	订购号 Order No.
	 <p>1 个双按钮 INO+INC , 包括标识牌“0, I, START, STOP” 1 个急停自锁按钮 INO+INC, 带刻字</p> <p>One double button INO+INC , Including label “0, I, START, STOP” One emergency stop self-locking button INO+INC, with engraved words</p>	1.160	CZ1242/1□-0250-2
	 <p>1 个信号灯带按钮 ● 红 LR INC+20V - 250V AC/DC 1 个信号灯带按钮 ● 绿 LG INO+20V - 250V AC/DC</p> <p>One Signal lamp with button component Red INC+20V - 250V AC/DC One Signal lamp with button component Green INO+20V - 250V AC/DC</p>	1.120	CZ1242/1□-0211-2

A

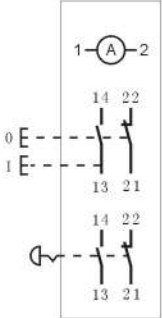
CZ1242/2 全塑防爆控制箱(操作柱) Full plastic Explosion-proof control box (operation post)

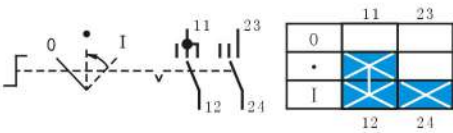
图样 Illustration	描述 Description	重量(kg) Weight	订购号 Order No.
	 <p>1 个电流表, 6A 100 / 15-M1, 电流互感器式 1 个双按钮 INO + INC 包括标识牌“0, I, START, STOP”</p> <p>One ammeter, 6A 100 / 15-M1, for current transformer One double button INO + INC Including label “0, I, START, STOP”</p>	1.450	CZ1242/2□-0201-0
	 <p>1 个电流表, 6A 100 / 15-M1 电流互感器式 1 个二极控制开关</p> <p>One ammeter, 6A 100 / 15-M1 For current transformer One 2-Pole control switch</p>	1.550	CZ1242/2□-0202-0

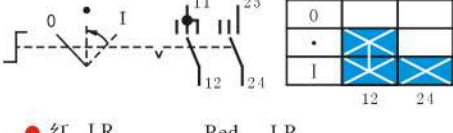
CZ1242/3 全塑防爆控制箱(操作柱) Full plastic Explosion-proof control box (operation post)

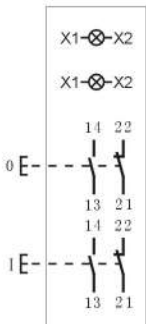
图样 Illustration	描述 Description	重量(kg) Weight	订购号 Order No.
	 <p>1个电流表, 6A 100 / 15-M1, 电流互感器式 1个双按钮 INO + INC 包括标识牌“0, I, START, STOP” 1个急停自锁按钮 INO+INC</p> <p>One ammeter, 6A 100 / 15-M1, for current transformer One double button INO + INC Including label " 0, I, START, STOP " One emergency stop self-locking button INO+INC. With engraved words</p>	1.650	CZ1242/2□-0353-0
	 <p>1个二极控制开关, 2个信号灯 ● 红 LR: 20V - 250V AC/DC ● 绿 LG: 20V - 250V AC/DC</p> <p>One 2-Pole control switch Two signal lamps</p>	1.500	CZ1242/2□-0304-0
	 <p>● 红 LR Red LR ● 绿 LG Green LG ● 黄 LY Yellow LY</p> <p>1个信号灯 20V - 250V AC/DC One signal lamp 1个电流表, 6A 100 / 15-M1 20V - 250V AC/DC 电流互感器式 For current transformer 1个二极控制开关 One 2-Pole control switch</p>	1.650	CZ1242/2□-0305-0 CZ1242/2□-0306-0 CZ1242/2□-0307-0
	 <p>2个信号灯 ● 红 LR: 20V - 250V AC/DC ● 绿 LG: 20V - 250V AC/DC 2个按钮 每个带 INO+INC , 包括标识牌“0, I, START, STOP”</p> <p>Two signal lamps ● Red LR: 20V - 250V AC/DC ● Green LG: 20V - 250V AC/DC Two buttons Each with INO+INC , Including label " 0, I, START, STOP "</p>	1.650	CZ1242/2□-0408-0

CZ1242/3 全塑防爆控制箱(操作柱) Full plastic Explosion-proof control box (operation post)

图样 Illustration	描述 Description	重量(kg) Weight	订购号 Order No.
	<p>1个电流表, 6A 100 / 15-M1 电流互感器式 2个信号灯 ● 红 LR: 20V - 250V AC/DC ● 绿 LG: 20V - 250V AC/DC 一个二极控制开关</p> <p>One ammeter, 6A 100 / 15-M1 For current transformer Two signal lamps ● Red LR: 20V - 250V AC/DC ● Green LG: 20V - 250V AC/DC One 2-pole control switch</p>	2.000	CZ1242/3□-0401-0
	<p>1个电流表, 6A 100 / 15-M1 电流互感器式 2个信号灯 2个按钮, 每个带 INO+INC 包括标识牌“0, I, START, STOP”</p> <p>One ammeter, 6A 100 / 15-M1 For current transformer Two signal lamps Two buttons, each with INO+INC Including label “0, I, START, STOP”</p>	2.070	CZ1242/3□-0502-0
	<p>2个信号灯 ● 红 LR: 20V - 250V AC/DC ● 绿 LG: 20V - 250V AC/DC 2个按钮, 每个带 INO+INC 包括标识牌“0, I, START, STOP”</p> <p>Two signal lamps ● Red LR: 20V - 250V AC/DC ● Green LG: 20V - 250V AC/DC Two buttons, each with INO+INC Including label “0, I, START, STOP”</p> <p>一个四极控制开关 One 4-Pole control switch</p>	2.000	CZ1242/3□-0503-0

A

电缆入口 Cable entries

L: -40℃ ≤ Ta ≤ +40℃ 使用环境温度
H: -40℃ ≤ Ta ≤ +55℃ Ambient temperature

编码 Code	0	2	8	J	K
规格 Specification	1个塑制 M32 × 1.5 One moulded plastic	1个塑制 M25 × 1.5 One moulded plastic	2个塑制 M25 × 1.5 Two moulded plastic	1个铜制 CZ0227/M25 × 1.5 One brass	1个铜制 CZ0227/M32 × 1.5 One brass
电缆直径 Φ Cable diameter Φ	12 ~ 21mm	8 ~ 17mm	8 ~ 17mm	11 ~ 15mm	11 ~ 19mm

CZ1242/1 全塑防爆控制箱 Full plastic Explosion-proof control box:

方案 Method

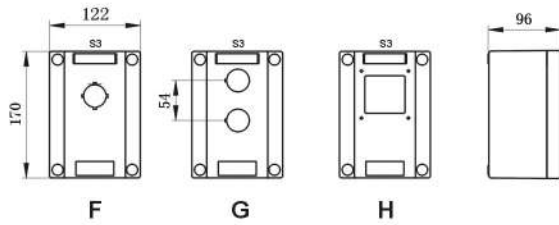
 元件安装数: ≤ 2 个
 The number of installed components: ≤ 2
CZ1242/2 全塑防爆控制箱 Full plastic Explosion-proof control box:

方案 Method

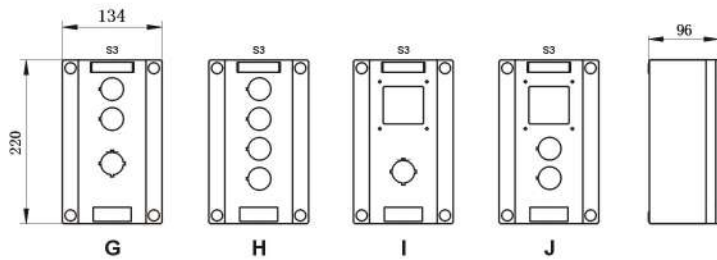

 元件安装数: ≤ 4 个
 The number of installed components: ≤ 4
CZ1242/3 全塑防爆控制箱 Full plastic Explosion-proof control box:

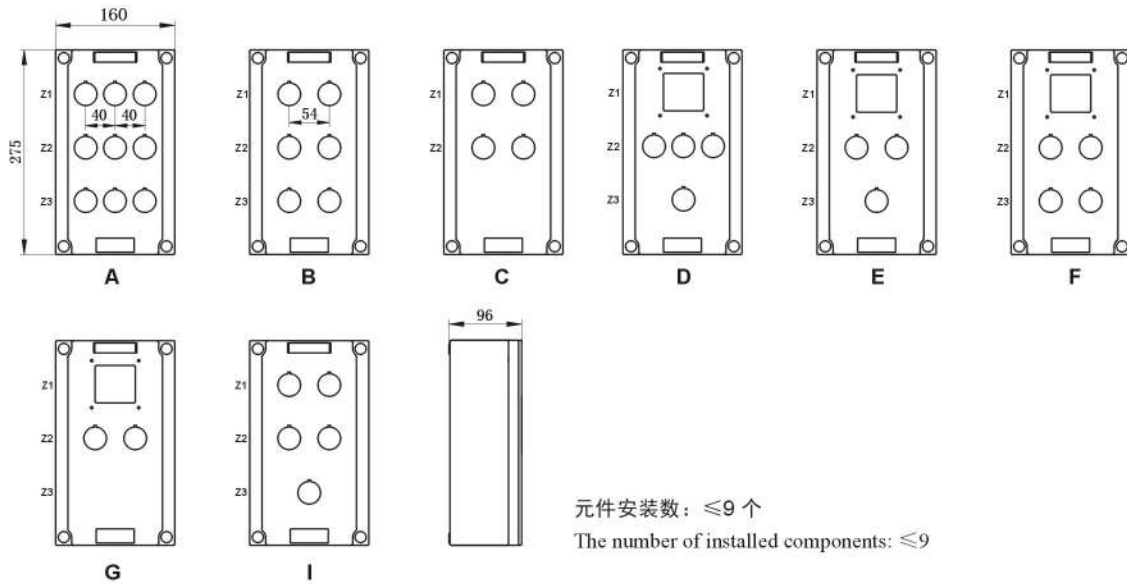
方案 Method

 元件安装数: ≤ 9 个
 The number of installed components: ≤ 9

CZ1242/001 全塑防爆控制箱 Full plastic Explosion-proof control box:

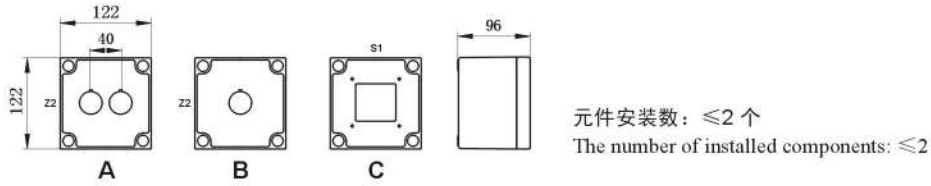
方案 Method



A

CZ1242/011 防爆控制箱 Explosion-proof control box:

方案 Method

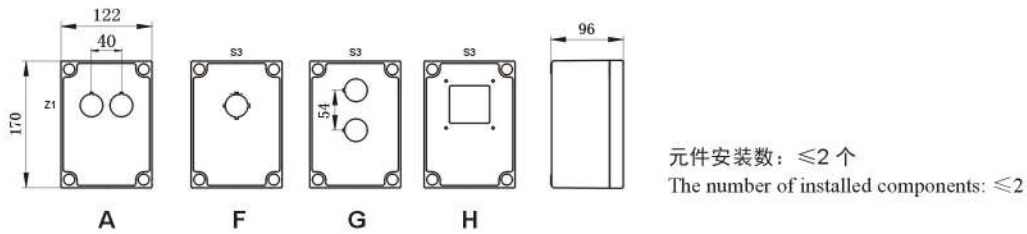

CZ1242/031、032 全塑防爆控制箱 Full plastic Explosion-proof control box:

方案 Method

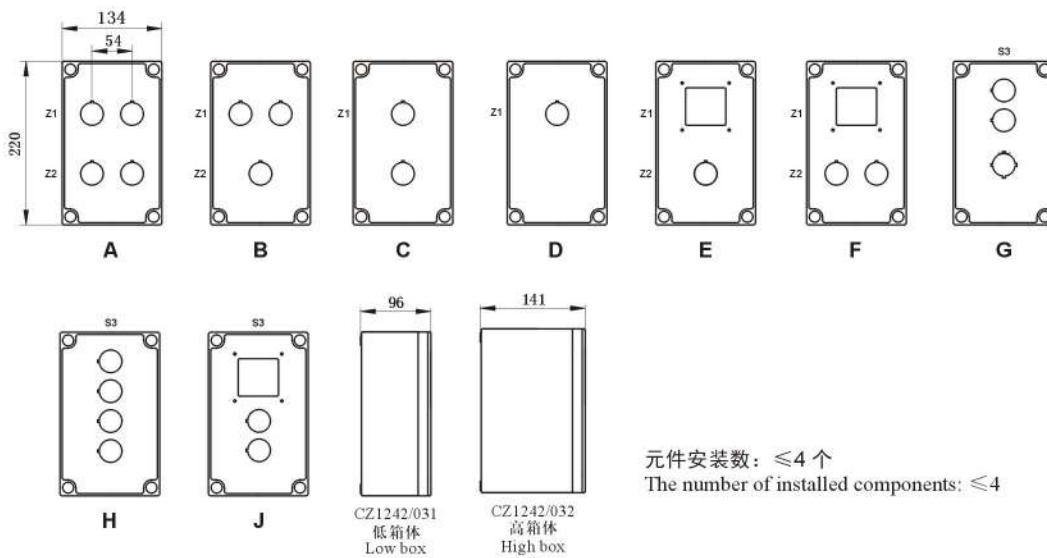

CZ1242/051、052 全塑防爆控制箱 Full plastic Explosion-proof control box:

方案 Method

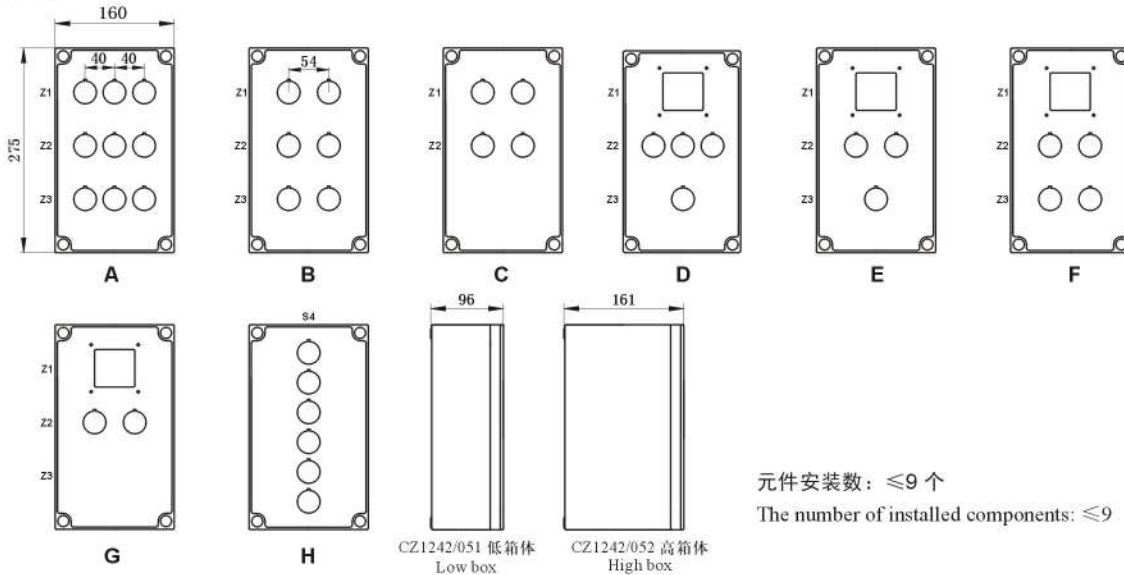

CZ1242/071、072 全塑防爆控制箱 Full plastic Explosion-proof control box:

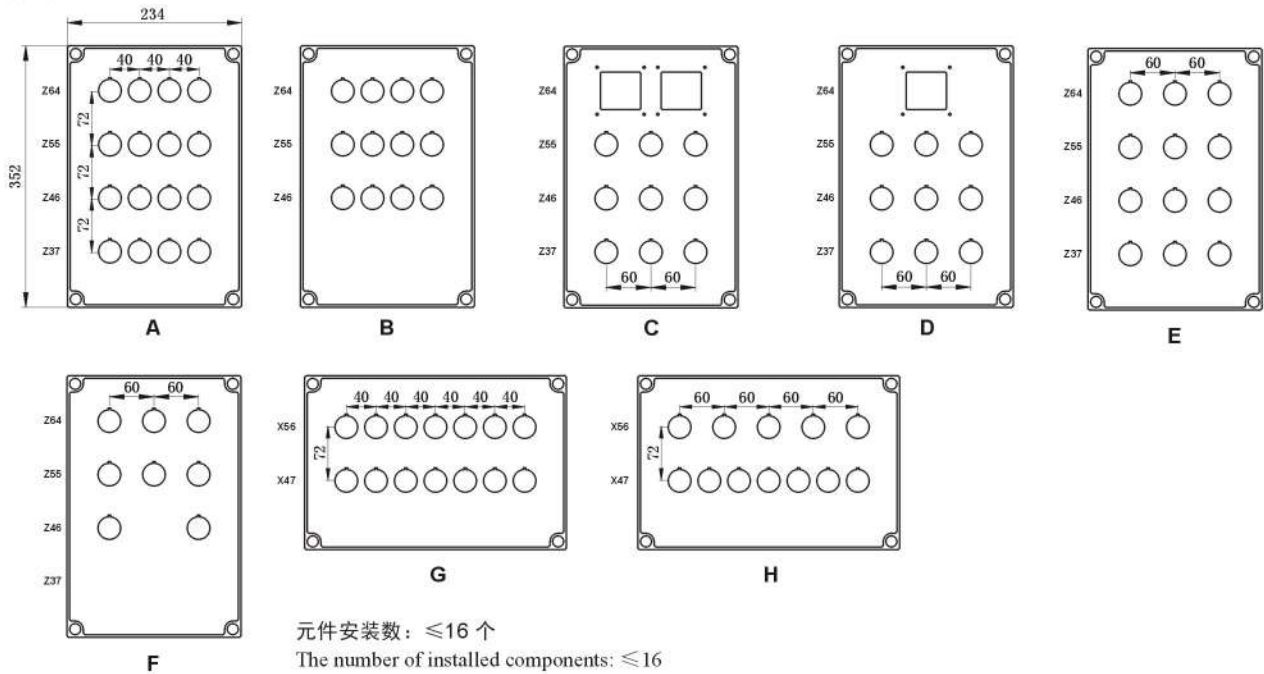
方案 Method

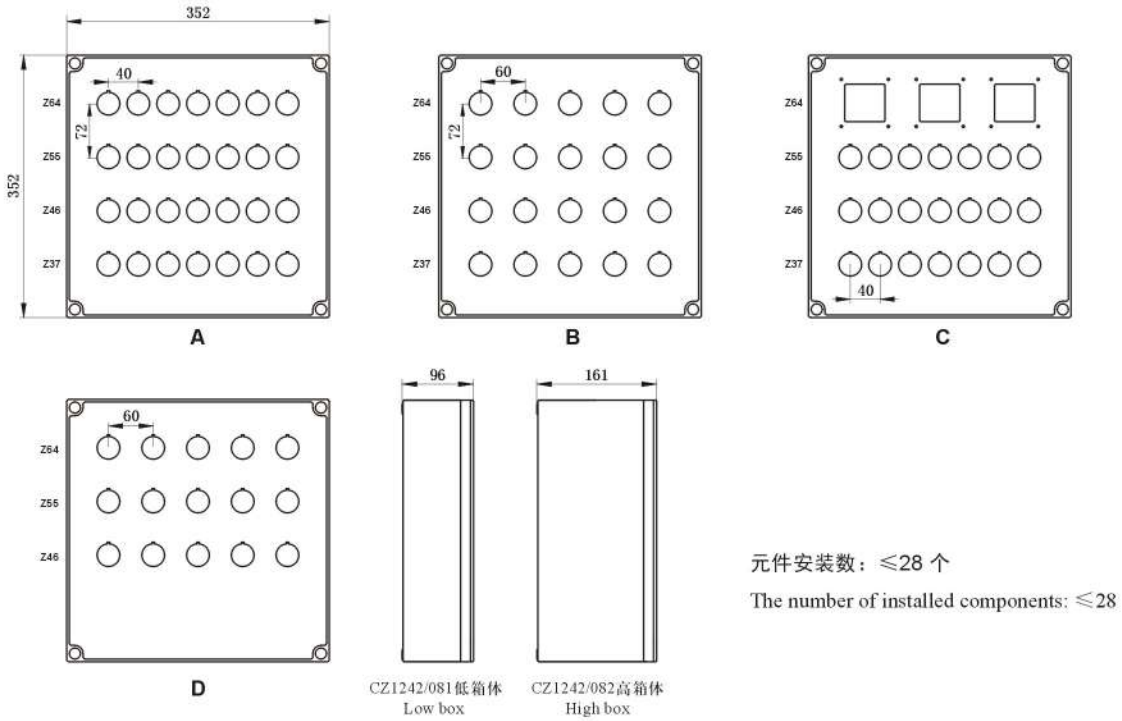

CZ1242/081、CZ1242/082 全塑防爆控制箱 Full plastic Explosion-proof control box:

方案 Method



A

CZ1242/092 全塑防爆控制箱 Full plastic Explosion-proof control box:

方案 Method

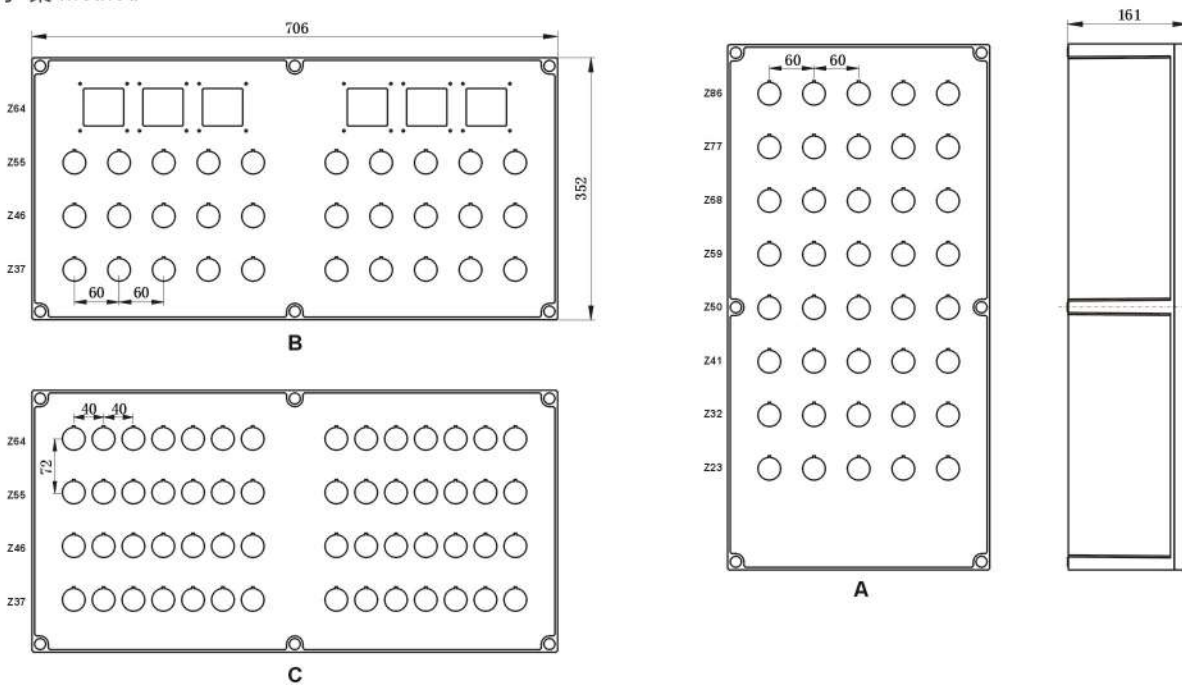

8000-□ 附件：接地螺丝 Accessories: Earthing screw

图样 Illustration	描述 Description	件/包 Pcs/package	重量(kg) Weight	编码 Code
	接地螺丝 M6 × 38mm Earthing screw M6 × 38mm	10	0.024	CZ8000-4036/6
	接地螺丝 M10 × 55mm Earthing screw M10 × 55mm	10	0.102	CZ8000-4036/10
	2 只铰链和 1 只挂锁套 Hinges 2pcs and padlock 1pcs	1	0.150	CZ8000-8046/01

 4000-□附件：墙壁、立式安装板和防雨罩
 Accessories: Wall, vertical mounting bracket and rain-proof cover

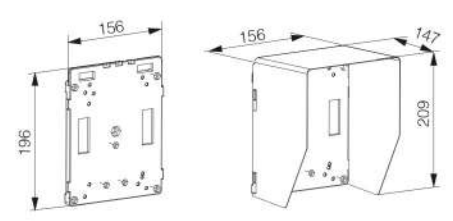
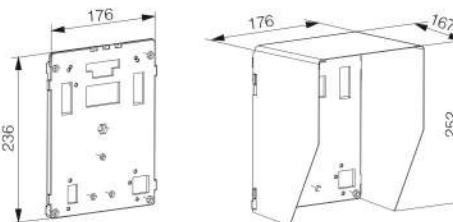
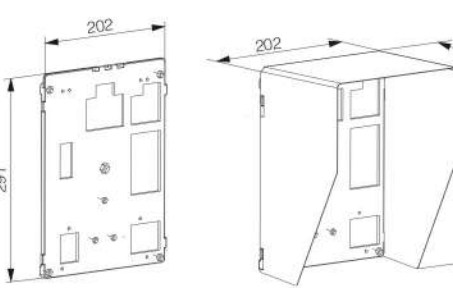
图样 Illustration	型号 Type	描述 Description	重量(kg) Weight	编码 Code
 <p>4038/11 4038/11P</p>	墙壁安装方式 Wall type mounting way	用于安装 CZ1242/1 Can be used for CZ1242/011	0.220	4038/11
		用于安装 CZ1242/2 Can be used for CZ1242/031	0.240	4038/12
		用于安装 CZ1242/3 Can be used for CZ1242/051	0.266	4038/13
 <p>4038/12 4038/12P</p>	墙壁式和立式 带不锈钢防雨罩 Wall type and vertical type with stainless steel water-proof cover	用于安装 CZ1242/1 Can be used for CZ1242/011	0.420	4038/11P
		用于安装 CZ1242/2 Can be used for CZ1242/031	0.710	4038/12P
		用于安装 CZ1242/3 Can be used for CZ1242/051	0.838	4038/13P
 <p>4038/13 4038/13P</p>	墙壁安装方式 Pendant type mounting way	墙壁式和立式 带不锈钢防雨罩 Pendant type and vertical type with stainless steel water-proof cover		

4000-□ 附件：立式脚盘 Accessory: Vertical foot tray

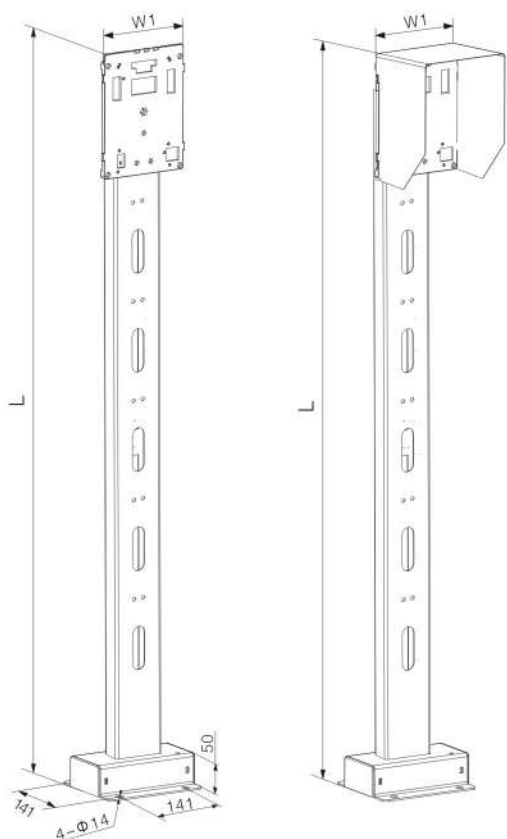

4032/□-11、12、13
立式脚盘
Vertical foot tray

4032/□-11P、12P、13P
带不锈钢防雨罩立式脚盘
Vertical foot tray with stainless
steel water-proof cover

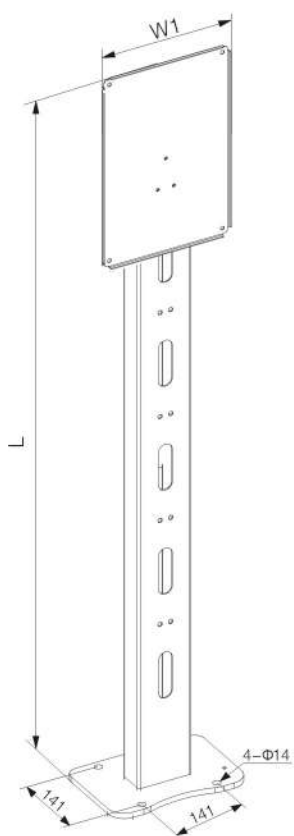

4032/□-14、15
立式脚盘
Vertical foot tray

型号 Type	描述 Description	重量(kg) Weight	编码 Code
立式脚盘 Vertical foot tray	用于安装 CZ1242/1 Can be used for CZ1242/011	4.170	4032/ □ -11
	用于安装 CZ1242/2 Can be used for CZ1242/031	4.190	4032/ □ -12
	用于安装 CZ1242/3 Can be used for CZ1242/051	4.216	4032/ □ -13
带不锈钢防雨罩 立式脚盘 Vertical foot tray with stainless steel water-proof cover	用于安装 CZ1242/1 Can be used for CZ1242/011	4.480	4032/ □ -11P
	用于安装 CZ1242/2 Can be used for CZ1242/031	4.660	4032/ □ -12P
	用于安装 CZ1242/3 Can be used for CZ1242/051	4.788	4032/ □ -13P
立式脚盘 Vertical foot tray	用于安装 CZ1242/071 Can be used for	7.260	4032/ □ -14
	用于安装 CZ1242/081 Can be used for	7.600	4032/ □ -15

- 27 — 碳钢 (表面电泳黑色)
27 — Carbon steel
(Surface electrophoresis black colour)
- 40 — 304 不锈钢
40 — No.304 Stainless steel
- 60 — 316L 不锈钢
60 — No.316L Stainless steel

材质 / Material

单位 Unit: mm

产品名称 Name	型号 Type	L	W1
立式脚盘 Vertical foot tray	4032/ □ -11	1312	156
	4032/ □ -12	1358	176
	4032/ □ -13	1398	202
带不锈钢防雨罩立式脚盘 Vertical foot tray with stainless steel water-proof cover	4032/ □ -11P	1325	156
	4032/ □ -12P	1371	176
	4032/ □ -13P	1413	202
立式脚盘 Vertical foot tray	4032/ □ -14	1355	236
	4032/ □ -15	1355	354

订购规格 Order specifications:

型号含义 Model implication:

CZ1242 / □ □ - T □ / □ - □ × □



A

元件、附件 Components:

- 1、每个板前导轨型内置元件都有特定的编码，编码和技术参数详见 A/125 ~ A/162 页。
 - 2、电缆入口的电缆密封套都有特定的编码，编码和技术参数详见 B/50 ~ B/67 页。
1. Each board front mounting rail type built-in component has special code, see pages A/125 ~ A/162 for code and technical data.
2. The cable gland for cable entry has special code, see pages B/50 ~ B/67 for code and technical data.

电缆入口方向 Direction of cable entry:

电缆入口要求在订单中说明，请指明侧面引入方向和位置。
The cable entries are required to indicate the directions and positions when order.

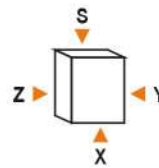

4000-□附件：立式脚盘 Accessory: Vertical foot tray

图样 Illustration	描述 Description	重量 (kg) Weight	编码 Code
<p>4005/□ 立式脚盘 4005/□ Vertical foot tray</p>	<p>配合立式脚盘使用： 4030 操作柱接头，铝制表面喷塑 With the use of vertical foot tray together: 4030 Joint of operation post, aluminum with plastic powder coated.</p>	0.457	L
	<p>立式脚盘用于安装 CZ1242/1 Vertical foot tray can be used for CZ1242/2 CZ1242/3</p>	4.67	4005/□

G: 304 不锈钢
G: No.304 Stainless steel

S: 优质钢表面电泳处理
S: Fine quality steel with electrophoresing surface

材质 / Material

外形及安装尺寸 Outline and installation dimensions:

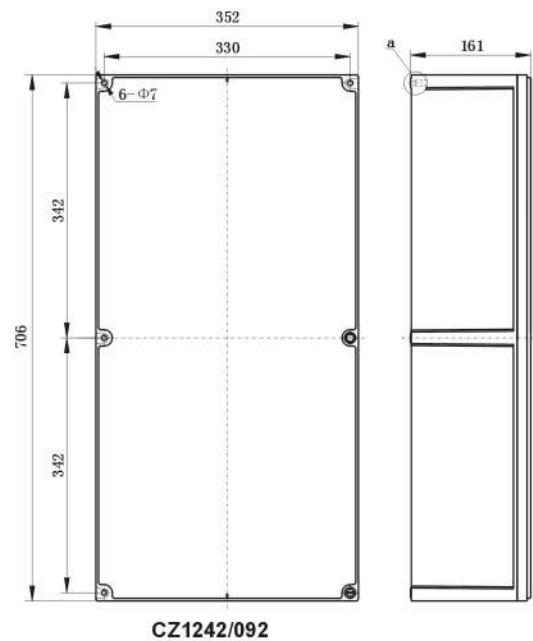
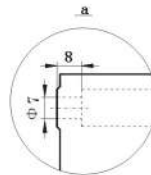
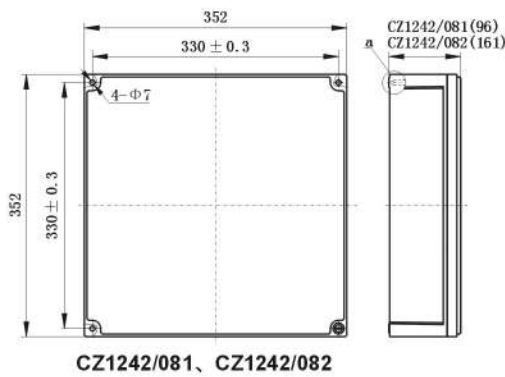
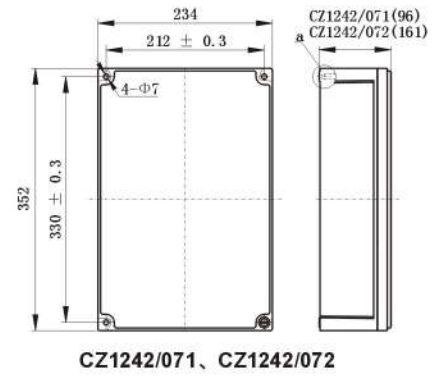
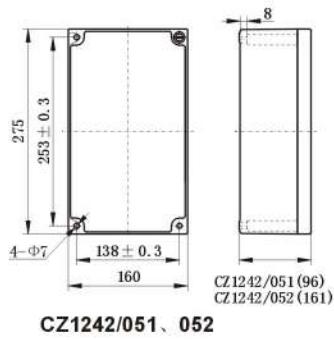
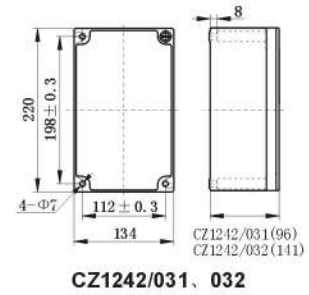
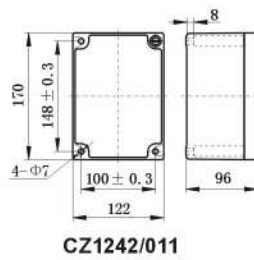
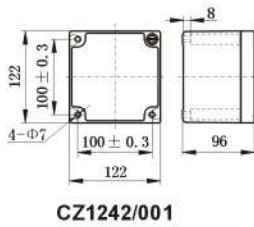
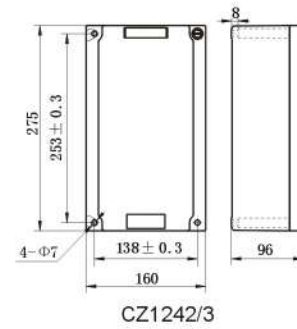
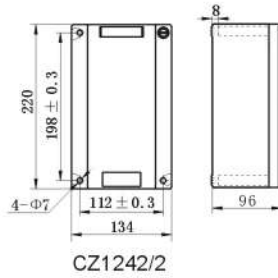
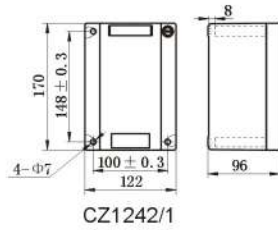
A

主要数据 Main technical data:

 适用范围: 用于 1 区和 2 区, 用于 21 区和 22 区
 使用环境温度: $-40^{\circ}\text{C} \leq \text{Ta} \leq +40^{\circ}\text{C}$
 $-55^{\circ}\text{C} \leq \text{Ta} \leq +55^{\circ}\text{C}$

防护等级: IP66 / IP65

外壳材料: GRP (抗静电玻璃纤维增强聚脂 SMC)

标配接地装置和导轨

 Intended use: Can be used in zone 1 and zone 2, Can be used in zone 21 and zone 22
 Ambient temperature: $-40^{\circ}\text{C} \leq \text{Ta} \leq +40^{\circ}\text{C}$
 $-55^{\circ}\text{C} \leq \text{Ta} \leq +55^{\circ}\text{C}$

Degree of protection: IP66 / IP65

Material of enclosure: GRP (anti-static glass fibre reinforced polyester SMC of static resistance)

Earthing device and mounting rail included

附件: 外壳 Accessorise: enclosure

图样 Illustration	防爆标志 Ex mark	电缆入口方向/数量 Direction of cable entry / Quantity	重量(kg) Weight	订购号 Order No.
	Ex eb IIC Gb Ex tb IIIC Db	X 底部 Bottom 2 × Φ20.5	0.822	CZ1242/1□-GT-1-X00
		X 底部 Bottom 2 × Φ25.5	0.822	CZ1242/1□-GT-1-X22
		X 底部 Bottom 2 × Φ25.5	0.822	CZ1242/1□-GT-1-X33
		X 底部 Bottom 1 × Φ32.5	0.822	CZ1242/1□-GT-1-X04
	Ex eb IIC Gb Ex tb IIIC Db	X 底部 Bottom 2 × Φ20.5	0.815	CZ1242/1□-GT-2-X00
		X 底部 Bottom 2 × Φ25.5	0.815	CZ1242/1□-GT-2-X22
		X 底部 Bottom 2 × Φ25.5	0.815	CZ1242/1□-GT-2-X33
		X 底部 Bottom 1 × Φ32.5	0.815	CZ1242/1□-GT-2-X04
	Ex eb IIC Gb Ex tb IIIC Db	X 底部 Bottom 2 × Φ20.5	0.827	CZ1242/1□-GT-A-X00
		X 底部 Bottom 2 × Φ25.5	0.827	CZ1242/1□-GT-A-X22
		X 底部 Bottom 2 × Φ25.5	0.827	CZ1242/1□-GT-A-X33
		X 底部 Bottom 1 × Φ32.5	0.827	CZ1242/1□-GT-A-X04
	Ex eb IIC Gb Ex tb IIIC Db	X 底部 Bottom 2 × Φ20.5	1.023	CZ1242/2□-GT-3-X00
		X 底部 Bottom 2 × Φ25.5	1.023	CZ1242/2□-GT-3-X22
		X 底部 Bottom 2 × Φ25.5	1.023	CZ1242/2□-GT-3-X33
		X 底部 Bottom 1 × Φ32.5	1.023	CZ1242/2□-GT-3-X04
	Ex eb IIC Gb Ex tb IIIC Db	X 底部 Bottom 2 × Φ20.5	1.015	CZ1242/2□-GT-4-X00
		X 底部 Bottom 2 × Φ25.5	1.015	CZ1242/2□-GT-4-X22
		X 底部 Bottom 2 × Φ25.5	1.015	CZ1242/2□-GT-4-X33
		X 底部 Bottom 1 × Φ32.5	1.015	CZ1242/2□-GT-4-X04
	Ex eb IIC Gb Ex tb IIIC Db	X 底部 Bottom 2 × Φ20.5	1.010	CZ1242/2□-GT-1A-X00
		X 底部 Bottom 2 × Φ25.5	1.010	CZ1242/2□-GT-1A-X22
		X 底部 Bottom 2 × Φ25.5	1.010	CZ1242/2□-GT-1A-X33
		X 底部 Bottom 1 × Φ32.5	1.010	CZ1242/2□-GT-1A-X04
	Ex eb IIC Gb Ex tb IIIC Db	X 底部 Bottom 2 × Φ20.5	1.001	CZ1242/2□-GT-2A-X00
		X 底部 Bottom 2 × Φ25.5	1.001	CZ1242/2□-GT-2A-X22
		X 底部 Bottom 2 × Φ25.5	1.001	CZ1242/2□-GT-2A-X33
		X 底部 Bottom 1 × Φ32.5	1.001	CZ1242/2□-GT-2A-X04

附件: 外壳 Accessorise: enclosure

图样 Illustration	防爆标志 Ex mark	电缆入口方向/数量 Direction of cable entry / Quantity	重量 (kg) Weight	订购号 Order No.
	Ex eb IIC Gb Ex tb IIIC Db	X 底部 Bottom 2 × Φ20.5	1.386	CZ1242/3□-GT-9-X00
		X 底部 Bottom 2 × Φ25.5	1.386	CZ1242/3□-GT-9-X22
		X 底部 Bottom 1 × Φ32.5	1.386	CZ1242/3□-GT-9-X33
		X 底部 Bottom 1 × Φ32.5	1.386	CZ1242/3□-GT-9-X04
	Ex eb IIC Gb Ex tb IIIC Db	X 底部 Bottom 2 × Φ20.5	1.386	CZ1242/3□-GT-6-X00
		X 底部 Bottom 2 × Φ25.5	1.386	CZ1242/3□-GT-6-X22
		X 底部 Bottom 1 × Φ32.5	1.386	CZ1242/3□-GT-6-X33
		X 底部 Bottom 1 × Φ32.5	1.386	CZ1242/3□-GT-6-X04
	Ex eb IIC Gb Ex tb IIIC Db	X 底部 Bottom 2 × Φ20.5	1.386	CZ1242/3□-GT-5-X00
		X 底部 Bottom 2 × Φ25.5	1.386	CZ1242/3□-GT-5-X22
		X 底部 Bottom 1 × Φ32.5	1.386	CZ1242/3□-GT-5-X33
		X 底部 Bottom 1 × Φ32.5	1.386	CZ1242/3□-GT-5-X04
	Ex eb IIC Gb Ex tb IIIC Db	X 底部 Bottom 2 × Φ20.5	1.386	CZ1242/3□-GT-4-X00
		X 底部 Bottom 2 × Φ25.5	1.386	CZ1242/3□-GT-4-X22
		X 底部 Bottom 1 × Φ32.5	1.386	CZ1242/3□-GT-4-X33
		X 底部 Bottom 1 × Φ32.5	1.386	CZ1242/3□-GT-4-X04
	Ex eb IIC Gb Ex tb IIIC Db	X 底部 Bottom 2 × Φ20.5	1.386	CZ1242/3□-GT-4A-X00
		X 底部 Bottom 2 × Φ25.5	1.386	CZ1242/3□-GT-4A-X22
		X 底部 Bottom 1 × Φ32.5	1.386	CZ1242/3□-GT-4A-X33
		X 底部 Bottom 1 × Φ32.5	1.386	CZ1242/3□-GT-4A-X04
	Ex eb IIC Gb Ex tb IIIC Db	X 底部 Bottom 2 × Φ20.5	1.386	CZ1242/3□-GT-3A-X00
		X 底部 Bottom 2 × Φ25.5	1.386	CZ1242/3□-GT-3A-X22
		X 底部 Bottom 1 × Φ32.5	1.386	CZ1242/3□-GT-3A-X33
		X 底部 Bottom 1 × Φ32.5	1.386	CZ1242/3□-GT-3A-X04
	Ex eb IIC Gb Ex tb IIIC Db	X 底部 Bottom 2 × Φ20.5	1.386	CZ1242/3□-GT-04A-X00
		X 底部 Bottom 2 × Φ25.5	1.386	CZ1242/3□-GT-04A-X22
		X 底部 Bottom 1 × Φ32.5	1.386	CZ1242/3□-GT-04A-X33
		X 底部 Bottom 1 × Φ32.5	1.386	CZ1242/3□-GT-04A-X04
	Ex eb IIC Gb Ex tb IIIC Db	X 底部 Bottom 2 × Φ20.5	1.386	CZ1242/3□-GT-2A-X00
		X 底部 Bottom 2 × Φ25.5	1.386	CZ1242/3□-GT-2A-X22
		X 底部 Bottom 1 × Φ32.5	1.386	CZ1242/3□-GT-2A-X33
		X 底部 Bottom 1 × Φ32.5	1.386	CZ1242/3□-GT-2A-X04

L: $-40^{\circ}\text{C} \leq T_a \leq +40^{\circ}\text{C}$ 使用环境温度
 H: $-55^{\circ}\text{C} \leq T_a \leq +55^{\circ}\text{C}$ Ambient temperature