



DOMOPLUS Series

Domestic standard sockets
IP66 with plug inserted

 **SCAME**
electrical solutions

DOMOPLUS Series

> DOMESTIC STANDARD SOCKETS FOR INDUSTRIAL APPLICATIONS



> TECHNICAL CHARACTERISTICS

Rated current:	10A-13A-15A-16A
Rated voltage:	250V~
Frequency:	50Hz
Insulating voltage:	250V~
Protection degree:	IP66 (also with plug inserted)
Operating temperature:	-5°C +60°C
Installation temperature:	-20°C +60°C
Glow Wire test:	650°C / 850°C
Halogen free:	Yes
Material:	Engineering plastic
Colour:	Base: gray RAL 7035 Cover: tinted polycarbonate

> REFERENCE STANDARDS

EN 60670-1 (2005-10)

Boxes and enclosures for electrical accessories for household and similar fixed electrical installations.
Part 1: general requirements.

> CABLING CAPACITY OF THE TERMINAL

Rated voltage	Rated current (A)	Sockets	
		Min	Max
250V~	10A	0,75	2,5
	13A	2,5	6
	15A	2,5	6
	16A	1	2,5

(mmq)

> AVAILABLE STANDARDS

ITALIAN STANDARD P17/11 - 16A



Shuttered socket
Italian standard
CEI 23-50

ITALIAN STANDARD P30 - 16A



Shuttered socket
Italian standard
CEI 23-50

PLURISTANDARD 16A



Shuttered socket

GERMAN STANDARD 16A



Shuttered socket
DIN VDE 0620

FRENCH STANDARD 16A



Shuttered socket
NFC 61-314

BRITISH STANDARD 13A



Shuttered socket
BS 1363-2

BRITISH STANDARD 15A



Shuttered socket
BS 546

ARGENTINIAN STANDARD 10A



Unshuttered socket
IRAM 2071

NEW ZEALAND STANDARD 10A



Unshuttered socket
AS/NZS 3112

SWISS STANDARD 10A



Unshuttered socket
SEV 1011:1998

SOUTH AFRICAN STANDARD 16A



Shuttered socket
SANS 164:1 (2006)

BRAZILIAN STANDARD 10A



Unshuttered socket
ABNT NBR 14136:2002

INDIAN STANDARD 6/16A



Shuttered socket
IS 1293:1988

> BEHAVIOUR WITH CHEMICAL AND ATMOSPHERIC AGENTS

Saline solution	Acids		Bases		Solvents				Mineral oil	UV rays
	Concentrated	Diluted	Concentrated	Diluted	Hexane	Benzol	Acetone	Alcohol		
Resistant	Limited Resistance	Resistant	Limited Resistance	Resistant	Resistant	Not Resistant	Not Resistant	Resistant	Limited Resistance	Resistant

For specific substances please contact our technical service.

> APPLICATION EXAMPLES

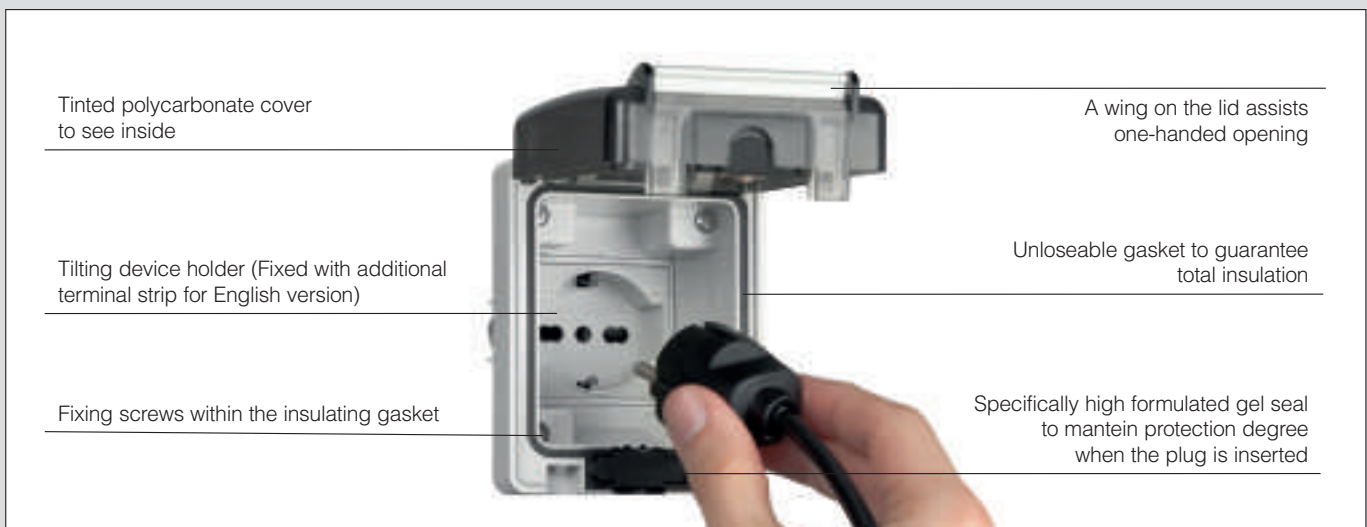

DOMOPLUS Series

DOMINO IP66 Series

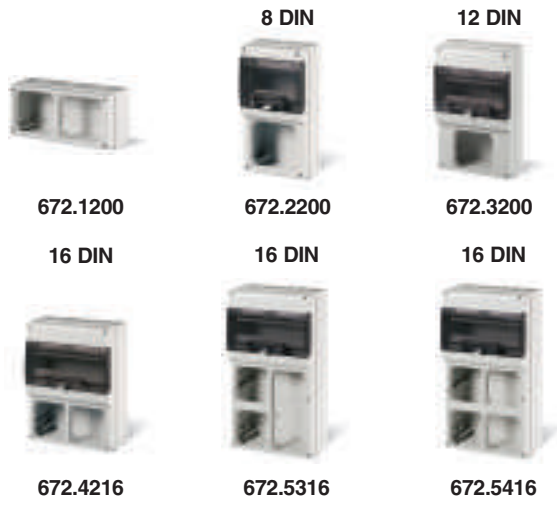

OMNIA System



MBOX Series



> COMPLEMENTARY PRODUCTS
FLANGE
136X125

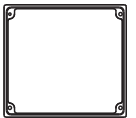

400/405



IP44/IP67
16-32A



IP67
63A

OMNIA Series

409



IP56
10-16A

401/406



IP44/IP67
16-32A

590



IP44
16-32A

ISOLATORS Series

DOMOPLUS
570.6405



> **COMPLEMENTARY PRODUCTS**
FLANGE
70X87

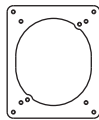

412/417 IP44/IP67 16-32A	242/247 IP44/IP67 16-32A	452/457 IP44/IP67 16-32A	EUREKA Series	200 IP44 16-32A	LIBERA Series
415 IP67 63A	430/435 IP44/IP67 16-32A	IEC309 Series	570 IP44	DOMO Series	
590 		COMMAND Series			

ADAPTO Series

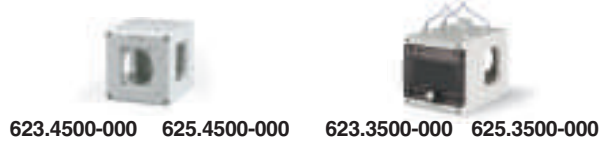

DOMINO IP66 Series

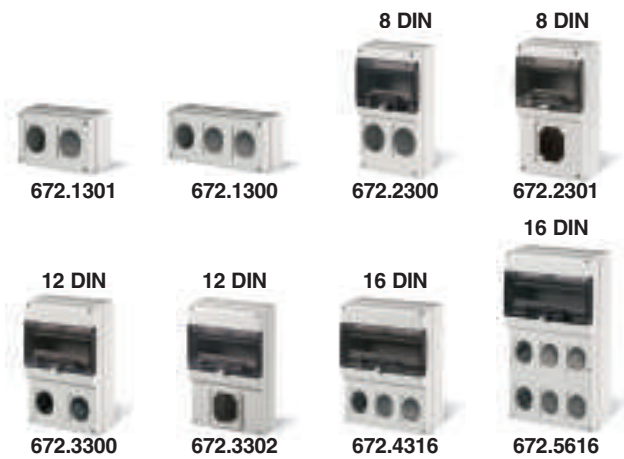

BLOCK Series

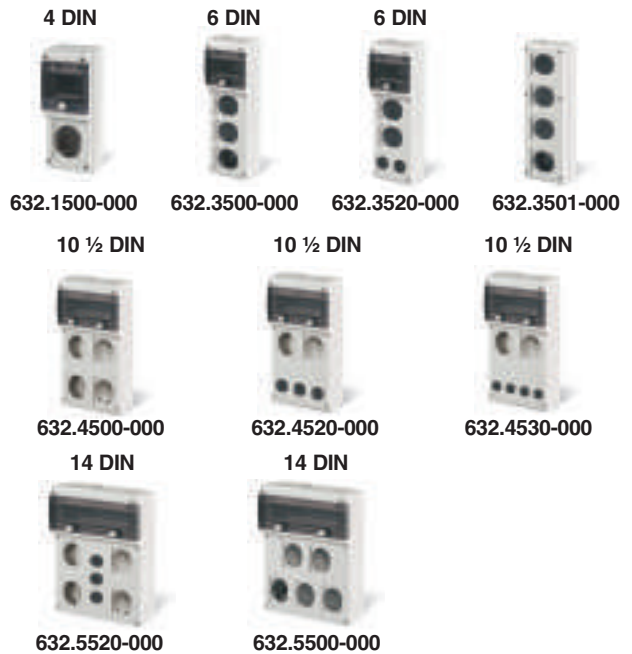

MBOX Series

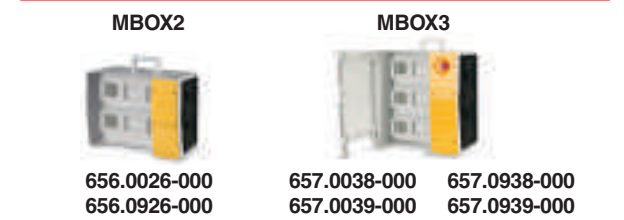

DOMOPLUS Series

> SOCKETS



	Description	Module	☐	
	Italian P11/17 (dual usage)	16A 2P+E	1/12	570.6403
	Italian (P30)	16A 2P+E	1/12	570.6404
	Italian (pluristandard)	16A 2P+E	1/12	570.6405
	French	16A 2P+E	1/12	570.6411
	German (Shuttered socket)	16A 2P+E	1/12	570.6407
	British	13A 2P+E	1/12	570.6413
	British	15A 2P+E	1/12	570.6414
	Argentinian	10A 2P+E	1/12	570.6424
	New Zealand	10A 2P+E	1/12	570.6427
	Swiss	10A 2P+E	1/12	570.6417
	South African	16A 2P+E	1/12	570.6428
	Brazilian	10A 2P+E	1/12	570.6421
	Indian	6/16A 2P+E	1/12	570.6429
	Data	RJ45 cat. 5E	1/12	570.6481.50

> SPARE PARTS



Description	Characteristics	☐	
2 gang enclosure	Tilting	1/12	570.6001
Gasket		10	137.202

☐ : Pack quantity





- Accepts inserts (sockets) EVOLUTION Series 1 / 2 gangs

> **BLOCK 3 DISTRIBUTION ASSEMBLIES**

Portable with cable and plug - MCB+RCD protected version

BLOCK 3 Series



Available sockets 16A					Power supply				
					Current	Poles	MCB	RCD 30mA	IP66
1	1		1		16A	3P+N+E	4P 16A (●)		630.3506-052
1			2			2P+E	2P 16A	2P 25A	630.3506-362
2			1			2P+E	2P 16A	2P 25A	630.3506-054
			3			2P+E	2P 16A	2P 25A	630.3506-055
2				1		2P+E	2P 16A	2P 25A	630.3506-056





(●) Residual Current circuit Breaker with Overcurrent protection (RCBO). (*) Available in the other domestic standards on page 6.

> **BLOCK 4 DISTRIBUTION ASSEMBLIES**

Portable with cable and plug - MCB+RCD protected version

BLOCK 4 Series



Available sockets 16A					Power supply				
					Current	Poles	MCB	RCD 30mA	IP66
1	1		1	1	16A	3P+N+E	4P 16A	4P 25A	630.4506-001
2			1	1		2P+E	2P 16A	2P 25A	630.4506-002
2			2			2P+E	2P 16A	2P 25A	630.4506-335
			2	2		2P+E	2P 16A	2P 25A	630.4506-010

(*) Available in the other domestic standards on page 6.



> MBOX DISTRIBUTION ASSEMBLIES

		Output unit										Power supply							
		Industrial sockets									Output protection				Input protection				
N° Sockets	Type	16A			32A			63A			2P+E ^(*)	MCB				RCD	Main switch		Power
		2P	2P+E	3P+E	3P+N+E	2P+E	3P+E	3P+N+E	3P+E	3P+N+E		16A		32A	30mA	SW DISC.	MCB	MAX	
												1P	2P	3P	4P	3P	A	A	A
6	MBOX2		5								1					25		16	6
			4	1							1		3	1		40		32	18
9	MBOX3		7								2	9				63		63	35
			4	2	2						1	5		2		63		63	35
			2	2	2		1	1			1	3		2	2	63		63	35

(*) Available in the other domestic standards on page 6.

> APPLICATION EXAMPLES





		Input unit		
		With plug		
with door	Plug		and emergency push button IP65	
	Polarity	A		
	2P+E	16		656.7826-1140
	3P+N+E	32		656.7826-1141
X	3P+N+E	63		657.8839-1137
X	3P+N+E	63		657.8839-1138
X	3P+N+E	63		654.8839-1139

> APPLICATION EXAMPLES







> DOMINO DISTRIBUTION ASSEMBLIES

Portable with cable and plug - MCB+RCD protected version

DOMINO Series



Available sockets - 16A					Power supply		Protection devices					Portable with cable and IEC309 plug IP66	
 2P+E	 3P+E	 3P+N+E	 ^(*) 2P+E	 ^(*) 2P+E	Current	Poles	Main		MCB 16A				
							MCB	RCD 30mA	1P	2P	3P	4P	
2	2		2		16A	3P+N+E	4P 16A	4P 25A	③	①			670.6566-111
3	2		1		32A	3P+N+E	-	4P 40A	3	1			670.6566-129

○ Switch-disconnectors.

(*) Available in the other domestic standards on page 6.

> APPLICATION EXAMPLES



> DIMENSIONS

570.6001

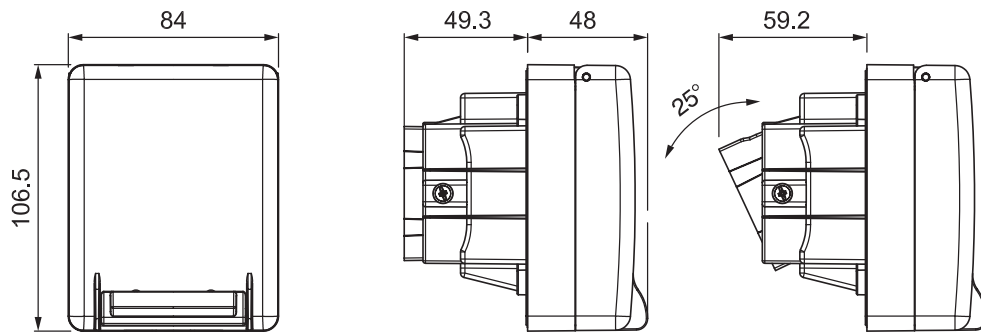

**570.6403 - 570.6404 - 570.6405 - 570.6411 - 570.6407 - 570.6424 - 570.6427
570.6417 - 570.6428 - 570.6421 - 570.6429 - 570.6481.50**

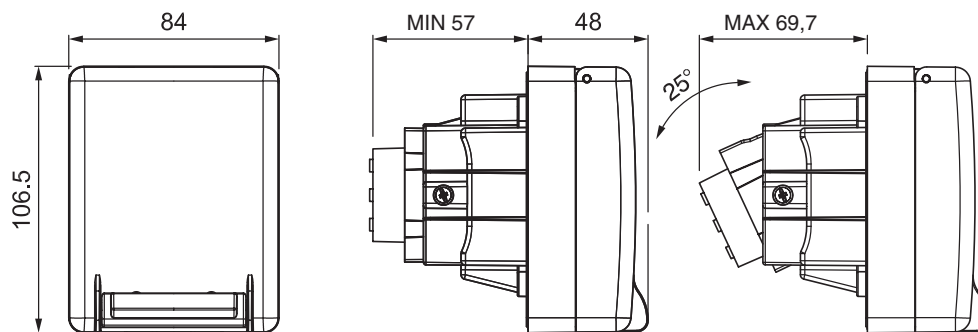

570.6413 - 570.6414

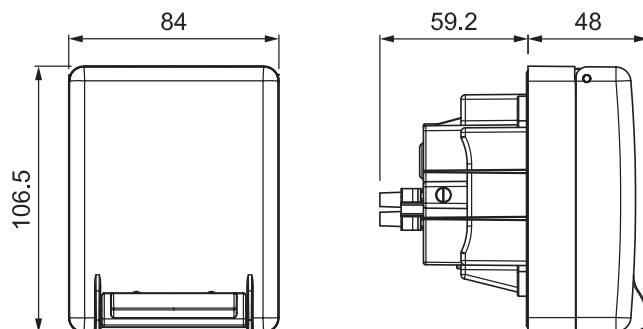

ZP00775-GB-1



ScameOnLine
www.scame.com
export@scame.com



SCAME PARRE S.p.A.
VIA COSTA ERTA, 15
24020 PARRE (BG) ITALY
TEL. +39 035 705000
FAX +39 035 703122

