



ATEX GENERAL CATALOGUE

 **SCAME**
electrical solutions

2016-2018



A T E X
CATALOGUE
2016-2018
www.scame.com

Scame: a growing group

IN LESS THAN FIFTY YEARS
WE HAVE BUILT AN
INDUSTRIAL BUSINESS THAT
HAS ALWAYS PRESERVED
THE SPIRIT OF ITS ORIGINS



Scame was founded amidst the enthusiasm of the Italian economic boom of the 60's and has always pursued its reason for being in thriving by improving. Today it is an international industrial group of about 800 people employed in 18 subsidiary and associated companies operating under the parent company headquartered in Parre (Bergamo) in Alta Valle Seriana. Scame has a capillary presence throughout Italy with its own sales agencies and operates worldwide with branches and loyal distributors.





Italy
Parre (Bergamo)

 **SCAME**^{ARGENTINA}
Argentina

 **SCAME**^{BULGARIA}
Bulgaria

 **SCAME**^{BRASIL}
Brazil

 **SCAME**^{CHILE}
Chile

 **SCAME-TOP**
China

 **SCAME-HR**
Croatia

 **SCAME-CZ**
Czech Republic

SOBEM  **SCAME**
France

 **SCAME**^{INDIA}
India



 **SCAME**_{POLSKA}
Poland

 **SCAME-SK**
Slovakia

 **SCAME-UK**
United Kingdom

 **SCAME**_{PORTUGAL}
Portugal

 **SCAME**_{IBERICA}
Spain

 **SCAME-UY**
Uruguay

 **SCAME-RO**
Romania

 **SCAME**_{MIDDLE EAST}
U.A.E.

 **SCAME-UA**
Ukraine

Technical and sales service

SEND AN E-MAIL TO THE ADDRESS infotech@scame.com AND YOU'LL RECEIVE THE ANSWERS TO ALL YOUR QUESTIONS ABOUT TECHNICAL ASPECTS, INSTALLATION AND CONFORMITY WITH THE STANDARDS .



The Scame technical information centre is able to promptly provide clear and complete answers to all your questions regarding the Scame products. The leading distributors of electrical material, with the support of our sales agencies and technical promoters, represent an additional capillary reference network. Information and updates can be found in the Info-point section of the internet site and in the newsletter sent periodically to the registered users.



infotech@scame.com

ADVANCE-GRP[GD] Series
page 18



OPTIMA-EX[GD] Series
page 26



ISOLATORS-EX[GD] Series
page 30



ZENITH-P Series
page 36

GAS&DUST

[Ex II 2 GD]

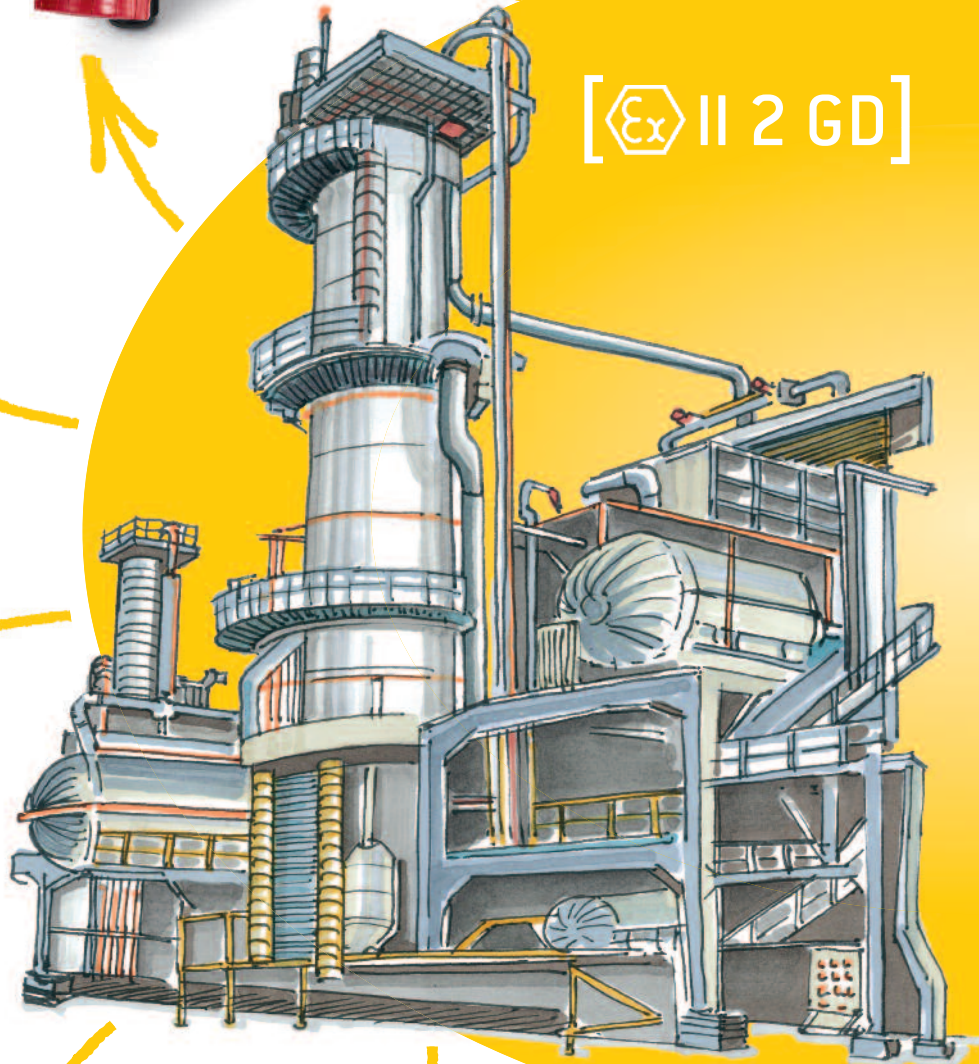

UNION-EX Series
page 54



ADVANCE-GRP[EX] Series
page 80



OPTIMA-EX Series
page 88

[ II 2 D]

DUST



ISOLATORS-EX Series
page 92



[ II 3 GD]
GAS&DUST

ALUBOX-EX Series
page 104

Guide to the ATEX directives

1. INTRODUCTION

What is ATEX?

“ATEX” is the acronym for “ATmosphere Explosive”, i.e., explosive atmosphere.

An explosive atmosphere is a mixture of flammable gases, vapours, mists or dusts with air, under specific atmospheric conditions in which, after ignition has occurred, combustion propagates to the flammable mixture.

In order for a potentially explosive atmosphere to form, the flammable substances must be present in a certain concentration. If the concentration is too low (lean mixture) or too high (rich mixture), no explosion occurs; instead there is just a slow combustion reaction or no reaction at all.

Thus the explosion can occur only in the presence of an ignition source and when the concentration is within the explosive range of the substances, i.e., between the lower explosive limit (LEL) and upper explosive limit (UEL). The explosive limits depend on the ambient pressure and the percentage of oxygen in the air.

ATEX DIRECTIVES

The European Union, regarding the hazard caused by a potentially explosive atmosphere, has adopted two harmonized directives on health and safety, known as ATEX 94/9/EC (also ATEX 100a, which, as of 20th April 2016, will be replaced by the new directive 2014/34/UE) and ATEX 99/92/EC (also ATEX 137). The ATEX Directive 94/9/EC sets out the Essential Safety Requirements for products and protective systems intended for use in potentially explosive atmospheres and the respective conformity assessment procedures. The ATEX Directive 99/92/EC, on the other hand, defines minimum health and safety requirements for workplaces with a potentially explosive atmosphere; in particular, it divides the workplaces into zones according to the probability of having an explosive atmosphere and specifies the basic criteria by which the equipment is selected within these zones. The ATEX Directive 94/9/EC was implemented in Italy with Legislative Decree 126/98 and applies to products placed on the market and/or

in service after 1 July 2003. The ATEX Directive 99/92/EC was implemented in Italy with Legislative Decree 233/03 and came into effect on 10 September 2003. The subsequent Legislative Decree 81/08 of 9 April 2008 (particularly Title XI- Protection from explosive atmospheres) and its update (Lgs.D. 106/2009 of 3/08/09, in effect as of 20 August) have since surpassed Lgs.D. 233/03. The figure below provides a schematic overview of the ATEX Directives and their correlation.

NEW ATEX DIRECTIVE

On 29th March 2014, the new ATEX directive 2014/34/EU was published. This new directive repeals, effective as from 20th April 2016, the Directive ATEX 94/9/EC.

The revision does not introduce substantial changes compared to the previous version; however, it pays more attention to the obligations of the various operators along the production chain, such as manufacturers, authorized representatives, importers and distributors.

The products and equipment placed on the market which complied with the previous directive can continue to be marketed on EU territory even after the new directive has become effective, provided they conform to the technical standards in force at that moment (indicated in the declaration of conformity of the product). As from 20th April 2016, the declarations of conformity of the products must obligatorily comply with the new directive.

SCOPE OF THE ATEX GUIDE

This document is a simple guide to the ATEX Directives, their meaning and how to select the best products suited for explosion hazard areas. The scope of the SCAME guide is to support, and not replace, the ATEX Directives by trying to provide valid information about the primary types of installations on which the ATEX Directives have an impact and inform the installer about the criteria for recognizing, selecting and correctly installing the SCAME products and solutions whose characteristics best suit the environment in question.

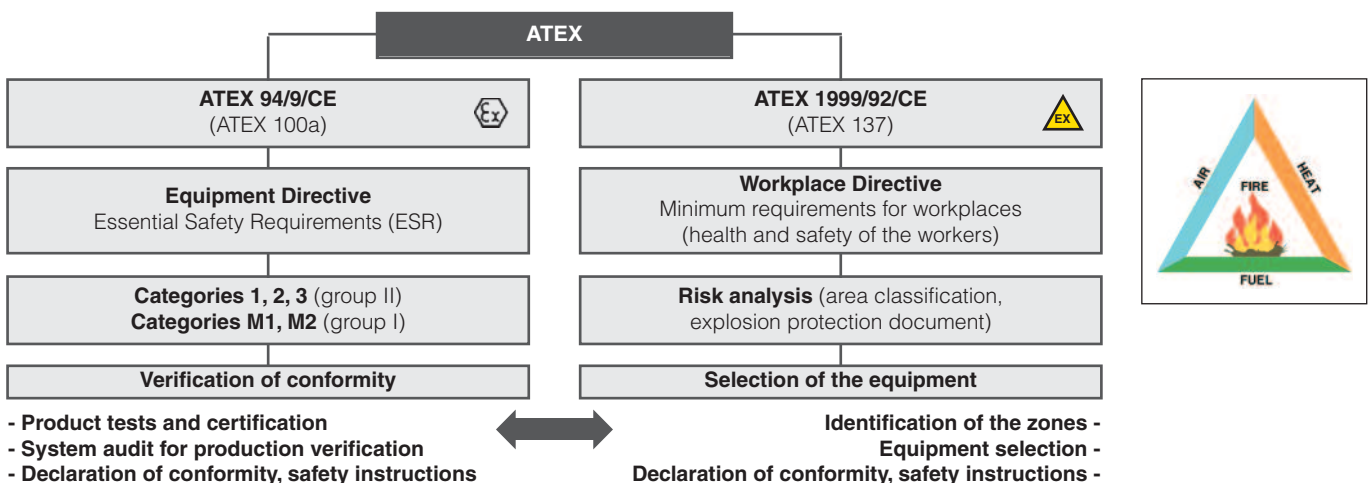

2. ATEX DIRECTIVE 94/9/EC: EQUIPMENT

The ATEX Directive has been effective throughout the European Union since 1 July 2003, replacing the various existing national and European legislations regarding explosive atmospheres; after that date it has been possible to market only those products conforming to the directive and supplied with the ATEX CE marking and EC declaration of conformity. It applies to all the electrical and mechanical equipment intended for use in explosion hazard areas, ranking among the directives that allow free trade of the goods and define the essential safety requirements (ESR) of the equipment which it covers. In particular, the directive defines the product categories and the characteristics the products must satisfy in order to be installed in explosion hazard areas.

It also describes the procedures that must be followed in order to obtain conformity.

The Directive's field of application also extends to safety, control and regulation devices that are installed outside the potentially explosive area, but on which the safety of the products installed in the explosive atmosphere depend.

PRODUCT CLASSIFICATION

The directive includes mining and surface installation materials since the hazard, protective measures and test methods are similar for both materials. The primary distinction is made with the division of the materials into two groups.

- **group I:** products to be used in gassy mines;
- **group II:** equipment intended for use on the surface.

Directive 94/9/EC classifies the products in categories, in relation to the level of protection and based on the degree of riskiness of the environment where they will be installed.

GROUP I PRODUCTS

The mining products are divided into 2 categories:

category M1: equipment or protective systems that guarantee a very high level of protection;

category M2: equipment or protective systems that guarantee a high level of protection; they must be able to be disconnected in the presence of the gas.

GROUP II PRODUCTS

The surface equipment (group II) is divided into 3 categories, based on the level of protection (zone of use); the categories

are identified by the number 1, 2, 3 followed by the letter G (Gas) or D (Dust).

- **category 1:** equipment or protective systems that guarantee a very high level of protection;
- **category 2:** equipment or protective systems that guarantee a high level of protection;
- **category 3:** equipment or protective systems that guarantee a normal level of protection.

CONFORMITY PROCEDURES

For marking purposes, there are various conformity procedures depending on the product and the category to which it belongs.

All **category 1 and category 2 electrical equipment** must mandatorily be **certified** by **ATEX Notified Bodies**, i.e., those bodies to which the national authority has assigned the task of verifying conformity with the Directive (in Italy, for example: IMQ, CESI, ICEPI, TUV, etc.).

The updated list of ATEX Notified Bodies (NB) is available on the site:

<http://ec.europa.eu/enterprise/newapproach/nando/>

For companies that manufacture category 1 and category 2 electrical equipment, the notification and monitoring of the quality system through an ATEX NB is also mandatory; the identification number of the body is reported on the plate along with the CE marking.

Self-certification is provided for all category 3 equipment with internal manufacturing control; in SCAME's case, the manufacturing control is fulfilled by the ISO 9001: 2008 company quality certification, issued by CSQ. The manufacturer must prepare the technical documentation that demonstrates the equipment's conformity with the requirements of the Directive; the documentation must remain available for at least 10 years after the last introduction on the market.

All products (category 1, 2 and 3) must mandatorily be accompanied by the written EC declaration of conformity and the instructions for use.

The table below specifies the type of certification required based on the category of the products.

Product category	EPL	Product certification by NB	Company certification by NB	Self-certification	Declaration of conformity and instructions for use
M1	Ma	YES	YES	NO	YES
M2	Mb	YES	YES	NO	YES
1G	Ga	YES	YES	NO	YES
1D	Da	YES	YES	NO	YES
2G	Gb	YES	YES	NO	YES
2D	Db	YES	YES	NO	YES
3G	Gc	Optional	NO	YES	YES
3D	Dc	Optional	NO	YES	YES

Guide to the ATEX directives

MARKING



The products must be equipped with the appropriate identification plate which must have, in addition to the CE marking, the specific marking of explosive protection (**Epsilon-x**, in the hexagon) followed by the **group** (I or II) and **category**; for **group II**, the letter **G** is added for equipment for Gas while equipment for dust is identified by the letter **D** (Dust).

In addition to the data required by the ATEX Directive, the plate must also indicate the type of protection as provided for by the standard and the information useful for correct identification and use of the product.

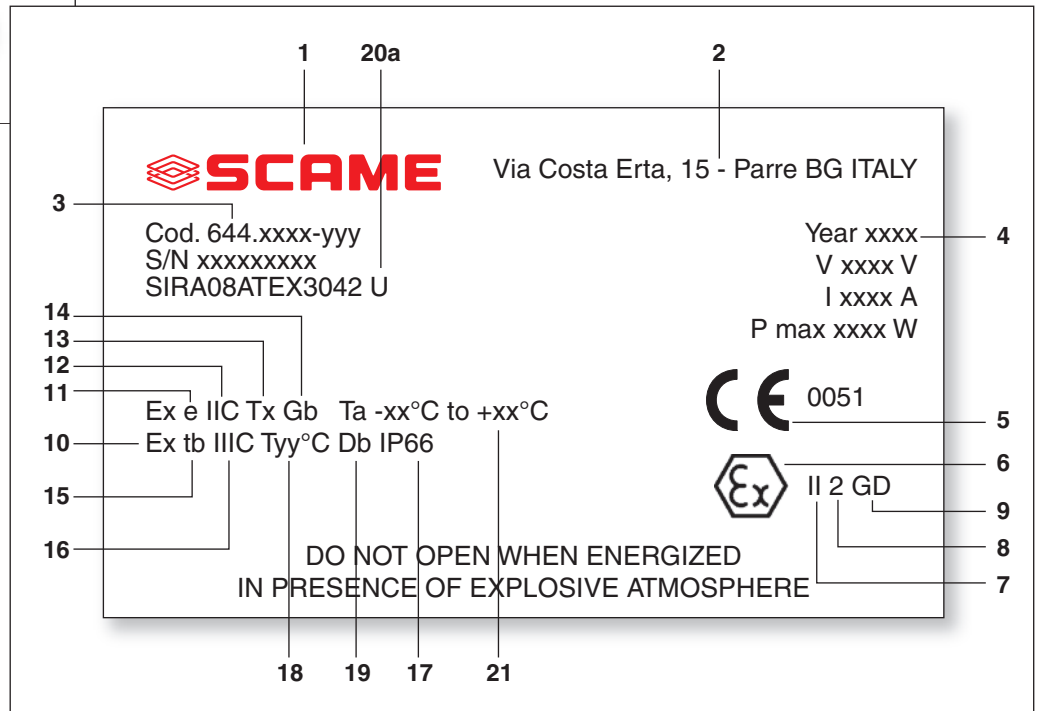

The table below specifies the main information provided on the product plates with relative explanatory notes and their meaning, with reference to the symbol numbers on the example plate.

MARKING EXAMPLE



GENERAL INFORMATION

N°	Marking	Meaning	Variants
1	SCAME	Manufacturer	-
2	Via Costa Erta 15 PARRE (BG) – ITALY	Manufacturer's address	-
3	Cod. 644.xxx-yyy	Product designation	-

N°	Marking	Meaning	Variants
4	2015	Year of manufacture	-
5		Conformity mark	For categories 1 and 2 it must be followed by the number of the notified body (*)
6		Specific marking of explosive protection	-
7	II	Equipment group	I: electrical equipment for mines II: electrical equipment for surface installations
8	2	Product category	1 for category 1 2 for category 2 3 for category 3
9	GD	Type of explosive atmosphere	G: gas D: dust GD: gas and dust

(*) Number (4-digit number) of the notified body responsible for ATEX company monitoring (for example: the number 0051 corresponds to IMQ, the number 0722 corresponds to CESI, etc.).

GAS (SPECIFIC INFORMATION)

10	Ex	Prefix of the types of protection for electrical equipment	-
11	e	Type of protection applied	Types of protection for GAS: - "d": explosion-proof enclosure - "e": increased safety - "ia" or "ib" or "ic": intrinsic safety, level of protection "ia" or "ib" or "ic" - "ma", "mb" or "mc": encapsulation, level of protection "ma" or "mb" - "nA": type of protection "nA" - "nC": type of protection "nC" - "nR": type of protection "nR" - "o": oil immersion - "px" or "py" or "pz": pressurized apparatus, level of protection "px" or "py" or "pz" - "q": powder filling
12	IIC	Flammable gas group	Group to which the flammable gas present on the installation belongs: IIA, IIB or IIC

(continue)

Guide to the ATEX directives

(follow)

GAS (SPECIFIC INFORMATION)

N°	Marking	Meaning	Variants
13	Tx	Temperature class = maximum temperature that the electrical equipment can reach	Temperature class (Group II): T1 = 450°C T2 = 300°C T3 = 200°C T4 = 130°C T5 = 100°C T6 = 85°C
14	Gb	EPL Gas	Gas equipment protection level (EPL): Ga: very high (suited for zone 0) Gb: high (suited for zone 1) Gc: increased (suited for zone 2)

DUST (SPECIFIC INFORMATION)

15	tb	Type of production applied	Types of protection for dust: - "ta", "tb" or "tc": protection by enclosure - "ia", "ib" or "ic": intrinsic safety protection - "ma", "mb" or "mc": protection with encapsulation - "px" or "py" or "pz": protection with pressurized enclosures, level of protection "px" or "py" or "pz"
16	IIIC	Group of combustible dust	Group to which the combustible dust present on the installation belongs: IIIA: fibres IIIB: non-conductive dust IIIC: conductive dust
17	IP66	Degree of protection (IP)	IP6X: apparatus suitable for Zone 22 with the presence of conductive dust IP5X: apparatus suitable for Zone 22 with the presence of non-conductive dust
18	Tyy°C	Maximum surface temperature that the electrical equipment can reach	Tyy°C: maximum surface temperature of the equipment expressed in °C
19	Db	EPL Dust	Combustible dust equipment protection level (EPL): Da: very high (suited for zone 20) Db: high (suited for zone 21) Dc: increased (suited for zone 22)

ADDITIONAL INFORMATION

20a	U	Indicates the ATEX components	"U": indicates an EX component
20b	X	Particular additional information	"X": indicates the presence of special conditions for safe use (to be checked on the certificate or in the instructions for use)
21	Ta -xx°C to +xx°C	Ambient temperature range	If not indicated, the range is: -20°C +40°C

REFERENCE STANDARDS FOR ELECTRICAL EQUIPMENT

The list below specifies the primary standards applicable for the construction and certification of the equipment, subdivided for gas and dust.

ELECTRICAL EQUIPMENT FOR GAS

IEC Standard	EN Standard	Contents
IEC 60079-0	EN 60079-0	General requirements
IEC 60079-1	EN 60079-1	Construction and testing of flameproof enclosures "d" for electrical equipment
IEC 60079-2	EN 60079-2	Electrical equipment, type of protection "p"
IEC 60079-5	EN 60079-5	Powder filling "q"
IEC 60079-6	EN 60079-6	Oil immersion "o"
IEC 60079-7	EN 60079-7	Increased safety "e"
IEC 60079-11	EN 60079-11	Intrinsic safety "i"
IEC 60079-15	EN 60079-15	Electrical equipment with type of protection "n"
IEC 60079-18	EN 60079-18	Encapsulation "m"

ELECTRICAL EQUIPMENT FOR DUST

IEC Standard	EN Standard	Contents
IEC 60079-0	EN 60079-0	General requirements for equipment for use in atmospheres with the presence of gas and dust.
IEC 60079-31	EN 60079-31	Protection by enclosures "t"
IEC 60079-2	EN 60079-2	Protection by pressurization "p"
IEC 60079-11	EN 60079-11	Protection by means of intrinsic safety "i"
IEC 60079-18	EN 60079-18	Protection by encapsulation "m"

Note: Always check the validity of the current standards on the site: <http://www.ceiweb.it>

1

ATEX-IECEX

[ II 2 GD]





Zone 1 (Gb)

Zone 2 (Gc)

Zone 21 (Db)

Zone 22 (Dc)

GAS&DUST

	1.1 ADVANCE-GRP[GD] Series PAGE 18
	1.2 OPTIMA-EX[GD] Series PAGE 26
	1.3 ISOLATORS-EX[GD] Series..... PAGE 30
	1.4 ZENITH-P Series..... PAGE 36
	1.5 UNION-EX Series PAGE 54

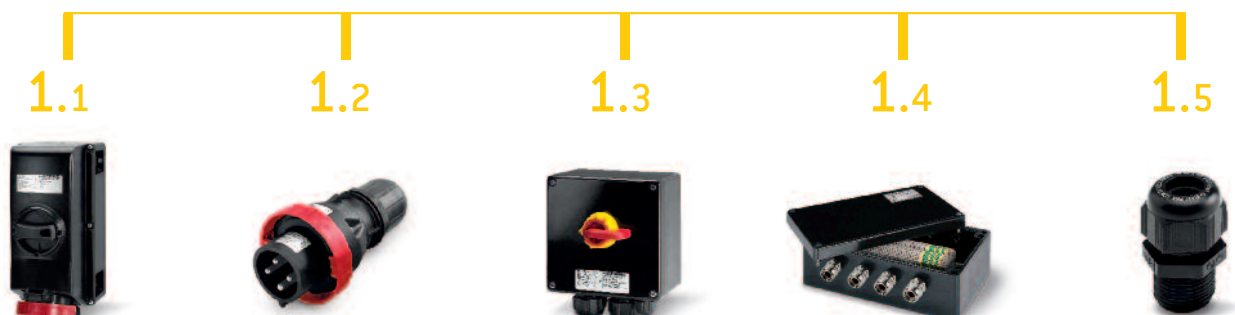

ADVANCE-GRP[GD] Series



ATEX [Ex] II 2 GD

SWITCHED INTERLOCKED SOCKET OUTLETS



VERSIONS WITH MECHANICAL INTERLOCK

	With switch-disconnector	16A-32A 63A-125A
--	--------------------------	---------------------

PRODUCTS FOR USE IN A POTENTIALLY EXPLOSIVE ENVIRONMENT

Scame offers products suitable for installation into environments under potential risk of explosion identified as Zone 1/2 and 21/22 and that enter into the field of application for the ATEX Directive (European Directive 94/9/CE and IECEx).



**SOCKET LABEL
ADVANCE-GRP[GD] SERIES**

504.1683	2015	 Via Costa Erta 15 Parre BG ITALY	
INERIS 15ATEX0017X			2P+⊕16A
IECEX INE15.0033X			6h 200-250V~
Ex de IIC T6 Gb			
Ex tb IIIC T80°C Db IP66			
Tamb. -35/+60°C			
WARNING: DO NOT OPEN WHEN AN EXPLOSIVE ATMOSPHERE IS PRESENT			

REFERENCE STANDARDS

- | | |
|---------------|---|
| ATEX
IECEX | IEC/EN 60079-0
Electrical apparatus for use in the presence of combustible dust.
<i>Part 0: General requirements.</i> |
| ATEX
IECEX | IEC/EN 60079-1
Explosive Atmospheres.
<i>Part 1: equipment protection by flameproof enclosures "d"</i> |
| ATEX
IECEX | IEC/EN 60079-31
Electrical apparatus for use in the presence of combustible dust.
<i>Part 31: Protection by enclosures 'tD'.</i> |
| ATEX
IECEX | IEC/EN 60079-7
Explosive Atmospheres.
<i>Part 7: equipment protection by increased safety "e"</i> |
| | IEC/EN 60309-1
Plugs, socket outlets and couplers for industrial purposes.
<i>Part 1: general requirements.</i> |
| | IEC/EN 60309-2
Plugs, socket outlets and couplers for industrial purposes.
<i>Part 2: dimensional interchangeability requirements for pin and contact-tube accessories of harmonised configurations.</i> |
| | IEC/EN 60309-4
Plugs, socket-outlets and couplers for industrial purposes.
<i>Part 4: Switched socket-outlets and connectors with or without interlock.</i> |

■ BEHAVIOUR WITH CHEMICAL AND ATMOSPHERIC AGENTS

Saline solution	Acids		Bases		Solvents				Mineral oil	UV rays
	Concentrated	Diluted	Concentrated	Diluted	Hexane	Benzol	Acetone	Alcohol		
Resistant	Limited Resistance	Resistant	Limited Resistance	Resistant	Resistant	Resistant	Resistant	Resistant	Resistant	Resistant

For specific substances please contact our technical service.

■ TECHNICAL CHARACTERISTICS

Rated current:	16A-32A-63A-125A
Rated voltage:	50-690V~
Frequency:	50-60Hz
Insulating voltage:	690V~
Switch-disconnectors:	16A-32A-63A: COMMAND-EX Series 125A: CZ0513
ATEX Code:	II 2 GD
Ex Protection type:	Ex d e IIC T4, T5, T6 Gb Ex tb IIIC T80°C Db IP66
Ambient temperature range:	-35°C + 60°C for socket 16/63/125A -50°C + 60°C for socket 32A
Maximum permissible surface temperature (DUST):	T80°C
Temperature class (GAS):	T4/T5/T6
Protection degree:	IP66
Impact Resistance:	7J
Switched socket outlets with interlock material:	Dissipative Thermosetting (GRP)
Colour:	Black RAL9005

■ ATEX IECEX CERTIFICATE

ATEX 16A-32A-63A-125A:
INERIS 15ATEX0017X

IECEX 16A-32A-63A-125A:
IECEX INE 15.0033X

■ WIRING OPERATIONS

Rated current (A)	Cable entry	Cable section (max).
16A	1xM25 (*)	12/18
32A	1xM32 (*)	16/25
63A	1xM40 (*)	22/32
125A	1xM50 (*)	28/38,5

(*) You can request the customised configuration of the cable input for the entire series of the ADVANCE-GRP[GD] socket. See table pg. 22.

■ ELECTRICAL FEATURES ADVANCE-GRP[GD] SERIES

Switch Socket Type		16/32A			63A			CZ0513-180A
Rated Voltage		400V	500V	690V	400V	500V	690V	690V
Category	AC3	-	25A	-	-	50A	-	125A
	AC22A	-	-	32A	-	-	63A	125A
	AC23A	-	32A	-	-	-	63A	125A

ADVANCE-GRP[GD] Series



SPECIAL CHARACTERISTICS

1
ATEX [Ex] II 2 GD
2
3



OUTSTANDING IMPACT RESISTANCE

The glass-fibre reinforced polyester used in **ADVANCE-GRP[GD]** and the high thickness of the casing walls guarantee an excellent mechanical resistance to impacts.

The **SMC** technology used to produce the casings makes **ADVANCE-GRP[GD]** an indestructible product.

The impact resistance of the casings is higher than 20J (IK10) according to EN50102, even under limit temperature conditions (-50°C +60°C).



RESISTANCE TO CHEMICAL AGENTS

The **ADVANCE-GRP[GD]** interlocked sockets and casings, thanks to the glass-fibre reinforced polyester with which they are produced, have excellent resistance to aggressive chemical substances, saline solutions, diluted acids, hydrocarbons, mineral oils, alcoholic substances. They are ideal for use in highly corrosive atmospheres.



RESISTANCE TO ATMOSPHERIC AGENTS

The structure and materials used also make **ADVANCE-GRP[GD]** a product suited for the most extreme environmental conditions. The degree of protection IP66, guarantees an excellent seal against the entry of solid objects or liquids into the casings. Outstanding resistance to UV radiation, exceptional reliability under environmental stress and use at both low and high ambient temperatures (-40°C +60°C) for 63/125A and (-50°C + 60°C) for 16/32A.



In the chemical and petrochemical plants, or, in general, in all those places where, a production process gives the possibility to forming a potentially explosive atmosphere are necessary electrical equipment that protect from the risk of explosion and they comply at ATEX Directive 94 /92/EC. SCAME complete the ATEX project, which currently covers only the dust area (Zone 21), introducing a safety switch designed and manufactured by SCAME till 80A suitable for GAS environments.

The plugs and sockets for Zone 1 unlike dust, require special design arrangements including the materials and the necessity of having a key insertion to prevent the connection of plugs of other builders, these and other, measures are required to prevent that any spark or arc, is formed through cutting the supply voltage, or at the time to coupling or decoupling plug and socket body, where they can come into contact with the surrounding atmosphere and cause an explosion.

CHARACTERISTICS

The **ADVANCE-GRP[GD]** product line includes a series of 16A, 32A, 63A, 125A interlocked sockets (compliant with EN60309-4 standards) and the casings to contain them. It's the most complete range of interlocked sockets produced in GRP (*Glass Reinforced Polyester*) thermosetting material.

A unique feature which enhances the exceptional mechanical strength of **ADVANCE-GRP[GD]** products is the **SMC** (*Sheet Moulding Compound*) production process used for the casings.

SMC is a technology which uses exclusively non-woven sheets, pre-impregnated with polyester resin. This method consists in preparing the sheet material inside a mould which, equipped with a negative mould, presses the composite so as to allow compaction.

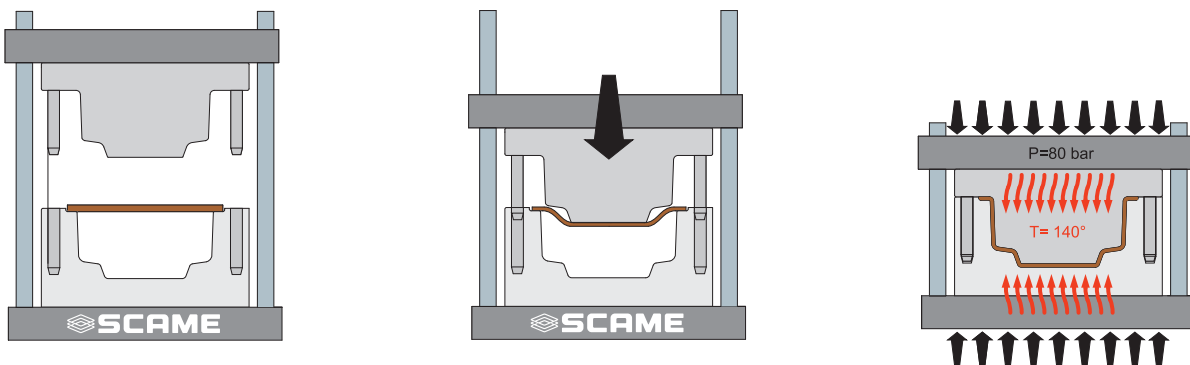

SMC is an advanced technology which enhances the quality of the raw material without reducing the high-strength characteristics during transformation; it's a high-performing technology in terms of the mechanical performance of the resultant product (glass fibre length, homogeneity of the material, integrity of the fibres).

On the contrary, the **BMC** (*Bulk Moulding Compound*) technology is a technology for moulding composite materials which uses a raw material available in "blocks" (short, charged fibres) which are subjected to high thermomechanical stress during the transformation process, consequently diminishing the mechanical properties of the details, thereby reducing the impact strength and flexural strength.

The glass-fibre reinforced polyester used in **ADVANCE-GRP[GD]** guarantees excellent mechanical strength and a long lifetime: this material is highly resistant to contamination, completely corrosion resistant and suited for applications requiring the use of components with low smoke emission and no halogens, **LSOH** (*Low Smoke Zero Halogen*) components. The outstanding properties of the material are also guaranteed over time, thanks to the high **RTI** value (*Relative Temperature Index*), measured to be 20,000h. Numerous verifications and tests have been carried out, even UV resistance tests, in order to guarantee the long duration of the material's initial performance.

The thickness of the walls is sufficient to offer an excellent alternative to aluminium, stainless steel or cast iron.



OUTSTANDING HEAT AND FIRE RESISTANCE

The glass-fibre reinforced polyester used in **ADVANCE-GRP[GD]** guarantees excellent heat and fire resistance: it does not propagate flames, emit halogens or smoke.

This material has outstanding flame retardancy: Glow Wire 960°C according to EN 60695-2-1; V0 according to UL94.

It's suited for applications requiring the use of components with low smoke emission and no halogens, **LSOH** (*Low Smoke Zero Halogen*).

ADVANCE-GRP[GD] Series



ELECTRICAL PARAMETERS - AUXILIARY CONTACT

ATEX Certification – Auxiliary Contact

Type	V _{max} - I _{max}	Mode of protection (Nm)	ATEX Certificate	Ambient Temperature
TECHNOR				
ZBWE 6	400V – 4A	Ex d e IIC	INERIS 02 ATEX 9007U	-50°C / +75°C
ZBWE 16	600V – 4A	Ex d e IIC	INERIS 02 ATEX 9007U	-50°C / +75°C
CORTEM (only for 63A size)				
M-0530 M-0531	400V – 4A	Ex d e IIC	CESI 09 ATEX 016 U	- 40°C / +80°C

IECEx Certification – Auxiliary Contact

Type	V _{max} - I _{max}	Mode of protection (Nm)	ATEX Certificate	Ambient Temperature
TECHNOR				
ZBWE 6	400V – 4A	Ex d e IIC	IECEx INE13.0063U	-50°C / +75°C
ZBWE 16	600V – 4A	Ex d e IIC	IECEx INE13.0063U	-50°C / +75°C
CORTEM (only for 63A size)				
M-0530 M-0531	400V – 4A	Ex d e IIC	IECEx CES 11.0031U	- 40°C / +80°C



The ambient temperature is limited by the auxiliary contacts when installed.
The ambient temperature is marked on the label and should not be used outside this range.

DRILLING AREA

The drilling area have to drilled respecting the minimum distance, and diameters e number of maximum hole indicated in table (Clearance).

Drilling Area	Dimensions	Socket Size	Cable gland size	Clearance			Max. drill holes
				A	B1	B2	
	80x45mm	16/32A	20mm 25mm 32mm	21mm 26mm 33mm	39mm 46mm 56mm	2 2 1	
	110x55mm	63A	25mm 32mm 40mm	26mm 33mm 41mm	46mm 56mm 70mm	2 2 1	
	196x72mm	125A top side (A)	25mm 32mm 40mm 50mm	26mm 33mm 41mm 51mm	46mm 56mm 70mm 78mm	5 3 2 2	
	72x72mm	125A bottom side (B1) (B2)	25mm 32mm 40mm 50mm	26mm 33mm 41mm 51mm	46mm 56mm 70mm 78mm	1 1 1 1	

CROSS SECTIONAL AREAS CONDUCTORS & TORQUE

TERMINALS CONTACTS - TORQUE		
ADVANCE-GRP[GD] – In	Cross Sectional Areas Conductors	Tightening Torque - (Nm)
16/32A	Cross Sectional Areas 10 mm ² finely-stranded	0.8
	16 mm ² single-wire	0.8
63A	25 mm ² finely-stranded	2.5
	35 mm ² single-wire	2.5
125A	50/70mm ² finely-stranded	3.5

EARTH TERMINALS

EARTH TERMINALS CONTACTS - TORQUE		
Type	Cross Sectional Areas Conductors	Tightening Torque - (Nm)
16/32A	10/16mm ²	1.2
63A	Weidmuller Ex e terminal type WPE35 35mm ²	3.5
125A	50/70mm ²	3.5

AUXILIARY CONTACTS

In the sockets ADVANCE-GRP[GD] type 16A, 32A, and 63A can be install as optional 2 auxiliary contacts maximum, on model type 125A is not possible to install auxiliary contacts.

They are optional accessories with ATEX/IECEX separate certificates. Installation and maintenance shall be done as prescribed by manufacturer documents.

HOW TO INSTALL AUXILIARY CONTACT

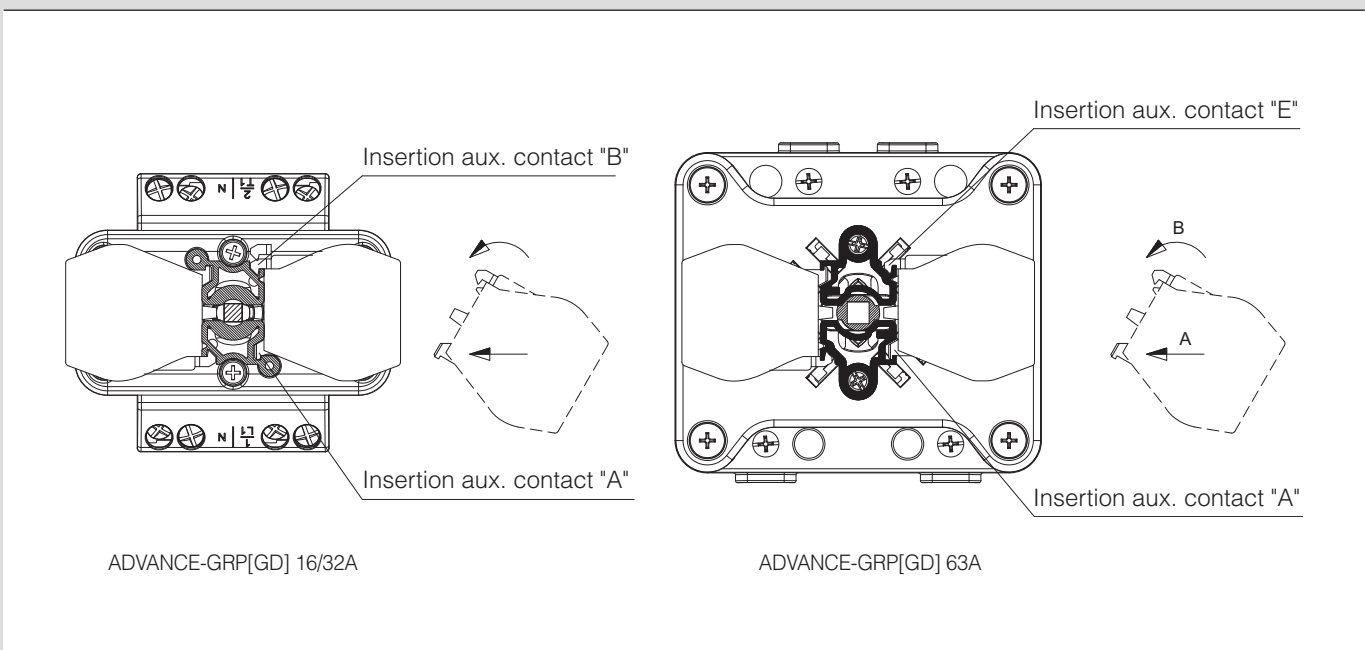

ADVANCE-GRP[GD] Series



ATEX / IECEx - 2 GD

Ambient	Gas			Dust		
Zone	0 - Ga	1 - Gb	2 - Gc	20 - Da	21 - Db	22 - Dc

SWITCHED INTERLOCKED SOCKET OUTLETS IP66

ATEX [Ex] II 2 GD

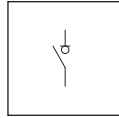

Poles	Hz	Volt	Colour		h.	16A	32A	63A	125A
			16A-32A 63A	125A		1xM25(*) □ 1	1xM32(*) □ 1	1xM40(*) □ 1	1xM50(*) □ 1
2P+E	50/60	100-130	Yellow	-	4	504.1670	504.3270	-	-
	50/60	200-250	Blue	-	6	504.1683	504.3283	-	-
	50/60	380-415	Red	-	9	504.1678	504.3278	-	-
	50/60	480-500	Red	-	7	504.16836	504.32836	-	-
	300÷500	50÷500	Red	-	2	504.16832	504.32832	-	-
	d.c.	50÷250	Red	-	3	504.16834	504.32834	-	-
	d.c.	>250÷500	Red	-	8	504.16838	504.32838	-	-
3P+E	50/60	100-130	Yellow	Black	4	504.1672	504.3272	504.6372	504.12572
	50/60	200-250	Blue	Black	9	504.1674	504.3274	504.6374	504.12574
	50/60	380-415	Red	Black	6	504.1686	504.3286	504.6386	504.12586
	60	440-460	Red	Black	11	504.16865	504.32865	504.63865	504.125865
	50/60	480-500	Red	Black	7	504.16866	504.32866	504.63866	504.125866
	50/60	600-690	Red	Black	5	504.16867	504.32867	504.63867	504.125867
	50/60	380/440	Red	Black	3	504.16864	504.32864	504.63864	504.125864
	100÷300	50÷690	Red	Black	10	504.16861	504.32861	504.63861	504.125861
>300÷500	50÷690	Red	Black	2	504.16862	504.32862	504.63862	504.125862	
3P+N+E	50/60	100-130	Yellow	Black	4	504.1679	504.3279	504.6379	504.12579
	50/60	208-250	Blue	Black	9	504.1675	504.3275	504.6375	504.12575
	50/60	346-415	Red	Black	6	504.1687	504.3287	504.6387	504.12587
	50/60	480-500	Red	Black	7	504.16876	504.32876	504.63876	504.125876
	50/60	600-690	Red	Black	5	504.16877	504.32877	504.63877	504.125877
	60	440-460	Red	Black	11	504.16875	504.32875	504.63875	504.125875
	50/60	380/440	Red	Black	3	504.16874	504.32874	504.63874	504.125874
>300÷500	50÷690	Red	Black	2	504.16872	504.32872	504.63872	504.125872	

□ Package/Bulk Pack.

(*) You can request the customised configuration of the cable input for the entire series of the ADVANCE-GRP[GD] socket.
See table pg. 22.

ACCESSORIES

EARTH STUD



AUXILIARY CONTACT

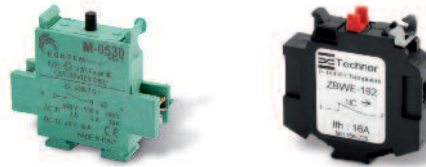

Description

Earth stud. 644.E650

CONFIGURATION SOCKET OPTIONAL ACCESSORIES

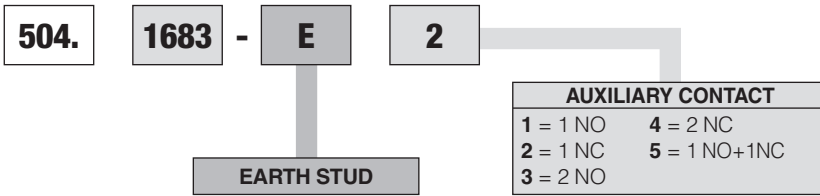

COMBINATIONS OF "POSSIBLE/NON POSSIBLE" PLUG/SOCKET CONNECTIONS

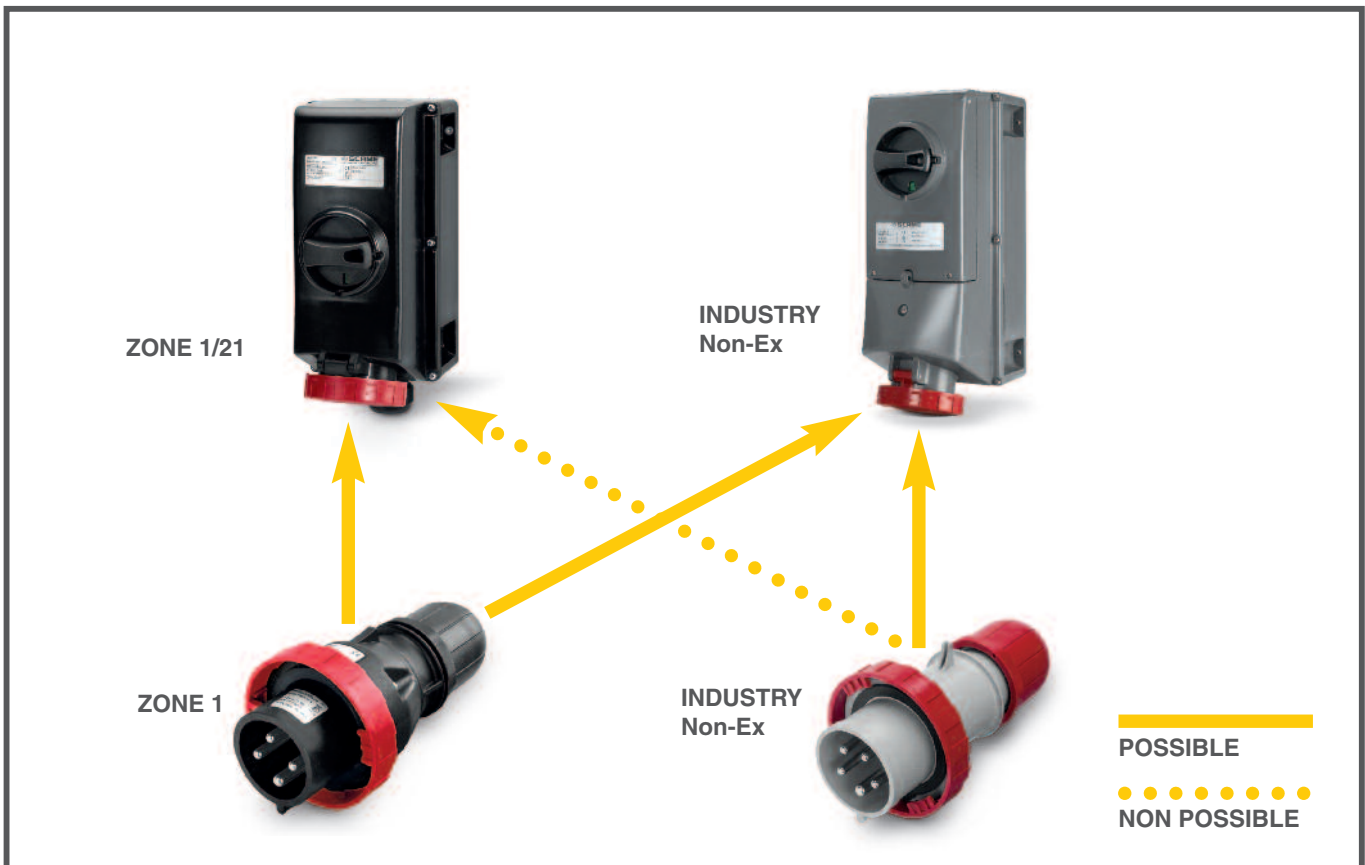

[Ex II 2 GD]

[Ex II 2 D]

[Ex II 3 GD]

OPTIMA-EX[GD] Series



ATEX [Ex II 2 GD]

PLUGS



VERSIONS



Plugs

16A-32A
63A-125A

PRODUCTS FOR USE IN A POTENTIALLY EXPLOSIVE ENVIRONMENT

Scame offers products suitable for installation into environments under potential risk of explosion identified as Zone 1/2 and 21/22 and that enter into the field of application for the ATEX Directive (European Directive 94/9/CE and IECEx).



PLUG LABEL
OPTIMA-EX[GD] SERIES

219.6336 Via Costa Erta 15 Parre BG ITALY	
INERIS 15ATEX0017X	
IECEx INE15.0033X	
Ex e IIC T6 Gb	
Ex tb IIIC T80°C Db IP66	
Tamb. -35/+60°C	
3P+ ±63A-6U 380-415V~	

REFERENCE STANDARDS

- ATEX IECEx**
IEC/EN 60079-0
 Electrical apparatus for use in the presence of combustible dust.
Part 0: General requirements.
- ATEX IECEx**
IEC/EN 60079-1
 Explosive Atmospheres.
Part 1: equipment protection by flameproof enclosures "d"
- ATEX IECEx**
IEC/EN 60079-31
 Electrical apparatus for use in the presence of combustible dust.
Part 31: Protection by enclosures 'tD'.
- ATEX IECEx**
IEC/EN 60079-7
 Explosive Atmospheres.
Part 7: equipment protection by increased safety "e"
- IEC/EN 60309-1**
 Plugs, socket outlets and couplers for industrial purposes.
Part 1: general requirements.
- IEC/EN 60309-2**
 Plugs, socket outlets and couplers for industrial purposes.
Part 2: dimensional interchangeability requirements for pin and contact-tube accessories of harmonised configurations.

■ BEHAVIOUR WITH CHEMICAL AND ATMOSPHERIC AGENTS

Saline solution	Acids		Bases		Solvents				Mineral oil	UV rays
	Concentrated	Diluted	Concentrated	Diluted	Hexane	Benzol	Acetone	Alcohol		
Resistant	Limited Resistance	Resistant	Limited Resistance	Resistant	Resistant	Resistant	Resistant	Resistant	Resistant	Resistant

For specific substances please contact our technical service.

■ TECHNICAL CHARACTERISTICS

Rated current:	16A-32A-63A-125A
Rated voltage:	50÷690V~
Frequency:	50÷60Hz
Insulating voltage:	690V~
ATEX Code:	Ex II 2 GD
Ex Protection type:	Ex e IIC T4, T5, T6 Gb Ex tb IIIC T80°C Db IP66
Ambient temperature range:	-50°C + 60°C for plug 16/32A -35°C + 60°C for plug 63/125A
Maximum permissible surface temperature (DUST):	T80°C
Temperature class (GAS):	T4/T5/T6
Protection degree:	IP66
Impact Resistance:	7J
Plugs material:	PA6 - Dissipative
Plugs colour:	Black RAL9011

■ ATEX IECEX CERTIFICATE

ATEX 16A-32A-63A-125A: **INERIS 15ATEX0017X**

IECEX 16A-32A-63A-125A: **IECEX INE 15.0033X**

■ ELECTRICAL FEATURES OPTIMA-EX[GD] SERIES

Rated Current	Maximun Current			Max. Cable Entry Temperature when Ta +60°C
	Ta 40°C	Ta 50°C	Ta 60°C	
16A	16A	16A	16A	80°C (*)
32A	32A	32A	32A	85°C (*)
63A	63A	63A	63A	90°C (*)
125A	100A	112A	125A	-

(*) WARNING: the cable entry can be reach high temperature; suitable cable can be used.

OPTIMA-EX[GD] Series



TECHNICAL FEATURES

1
ATEX [Ex II 2 GD]
2
3

OPTIMA-EX[GD] SERIES	Unit		Value			
Rated Current			16A	32A	63A	125A
Code			219.16...	219.32...	219.63...	219.125...
Suitable Size cables Ground-Terminals	(mm ²)		2,5	6	10	25
Power Supply Terminals - Tightening-Torque	(Nm)		1	1,5	2	4
Cable size accepted by Cable-Clamp (eg.H07RN-F) Do not use armoured cable	(mm)	2P+E	14	16	21	30
		3P+E				
		3P+N+E				
Cable Gland/Cable-Clamp Tightening-Torque	(Nm)	2P+E	5,6	10	10	25
		3P+E				
		3P+N+E				
Cable-Gland/Cable-Clamp (Screw) - Tightening-Torque	(Nm)		0.8	0.8	0.8	0.8
Handle Screws – Tightening-Torque	(Nm)		1	1	1,2	1,2

Ambient	Gas			Dust		
Zone	0 - Ga	1 - Gb	2 - Gc	20 - Da	21 - Db	22 - Dc

PLUGS IP66

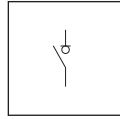

Poles	Hz	Volt	Colour		h.	16A	32A	63A	125A
			16A-32A 63A	125A		cable gland □ 10/40	cable gland □ 10/40	cable gland □ 6/24	cable gland □ 1/8
2P+E	50/60	100-130	Yellow	-	4	219.1630	219.3230	-	-
	50/60	200-250	Blue	-	6	219.1633	219.3233	-	-
	50/60	380-415	Red	-	9	219.1638	219.3238	-	-
	50/60	480-500	Red	-	7	219.16336	219.32336	-	-
	300÷500	50÷500	Red	-	2	219.16332	219.32332	-	-
	d.c.	50÷250	Red	-	3	219.16334	219.32334	-	-
	d.c.	>250÷500	Red	-	8	219.16338	219.32338	-	-
3P+E	50/60	100-130	Yellow	Black	4	219.1631	219.3231	219.6331	219.12531
	50/60	200-250	Blue	Black	9	219.1634	219.3234	219.6334	219.12534
	50/60	380-415	Red	Black	6	219.1636	219.3236	219.6336	219.12536
	60	440-460	Red	Black	11	219.16365	219.32365	219.63365	219.125365
	50/60	480-500	Red	Black	7	219.16366	219.32366	219.63366	219.125366
	50/60	600-690	Red	Black	5	219.16367	219.32367	219.63367	219.125367
	50/60	380/440	Red	Black	3	219.16364	219.32364	219.63364	219.125364
	100÷300	50÷690	Red	Black	10	219.16361	219.32361	219.63361	219.125361
>300÷500	50÷690	Red	Black	2	219.16362	219.32362	219.63362	219.125362	
3P+N+E	50/60	100-130	Yellow	Black	4	219.1632	219.3232	219.6332	219.12532
	50/60	208-250	Blue	Black	9	219.1635	219.3235	219.6335	219.12535
	50/60	346-415	Red	Black	6	219.1637	219.3237	219.6337	219.12537
	50/60	480-500	Red	Black	7	219.16376	219.32376	219.63376	219.125376
	50/60	600-690	Red	Black	5	219.16377	219.32377	219.63377	219.125377
	60	440-460	Red	Black	11	219.16375	219.32375	219.63375	219.125375
	50/60	380/440	Red	Black	3	219.16374	219.32374	219.63374	219.125374
>300÷500	50÷690	Red	Black	2	219.16372	219.32372	219.63372	219.125372	

□ Package/Bulk Pack.

PLUGS COVER

	Description	□	Description	□
	2P+E	10/100	32A-30A 3P+N+E	10/100
	16A-20A 3P+E	10/100	63A-60A 2P+E, 3P+E and 3P+N+E	10/100
	3P+N+E	10/100	125A-100A 2P+E, 3P+E and 3P+N+E	10/100
	32A-30A 2P+E and 3P+E	10/100		

[Ex II 2 GD]

[Ex II 2 D]

[Ex II 3 GD]



Scame**OnLine**
www.scame.com
atex@scame.com

SCAME PARRE S.p.A.
 VIA COSTA ERTA, 15
 24020 PARRE (BG) ITALY
 TEL. +39 035 705000
 FAX +39 035 703122

