













## CARTUCHOS FUSIBLES NH (APR) INDUSTRIALES

FUSIBLES NH gG 500V INDICADOR SUPERIOR

gL/gG500V



## FUSIBLES NH gG 500V INDICADOR SUPERIOR

In (A)	REFERENCIA	U (V)	PODER DE CORTE (kA)	EMBALAJE Unid./CAJA
<b>NH000</b> T-00				
2	381000	500	120	3/120
4	381005	500	120	3/120
6	381010 	500	120	3/120
10	381015 	500	120	3/120
16	381020 	500	120	3/120
20	381025 	500	120	3/120
25	381030 	500	120	3/120
32	381035 	500	120	3/120
35	381040 	500	120	3/120
40	381045 	500	120	3/120
50	381050 	500	120	3/120
63	381055 	500	120	3/120
80	381060 	500	120	3/120
100	381065 	500	120	3/120



381045

**NH00**

125	381070 	500	120	3/60
160	381075 	500	120	3/60

**NH0**

<b>NH0</b> T-0				
6	381110	500	120	3/36
10	381115	500	120	3/36
16	381120	500	120	3/36
20	381125	500	120	3/36
25	381130	500	120	3/36
32	381135	500	120	3/36
35	381140	500	120	3/36
40	381145	500	120	3/36
50	381150	500	120	3/36
63	381155	500	120	3/36
80	381160	500	120	3/36
100	381165	500	120	3/36
125	381170	500	120	3/36
160	381175	500	120	3/36



381165

**NH0 S**

200	381180	500	120	3/60
224	381185	500	120	3/60
250	381190	500	120	3/60

## CARTUCHOS FUSIBLES NH (APR) INDUSTRIALES

FUSIBLES NH gG 500V INDICADOR SUPERIOR

# gL/gG500V

In (A)	REFERENCIA	U (V)	PODER DE CORTE (kA)	EMBALAJE Unid./CAJA
<b>C1</b>				
	T-1			
50	381230	500	120	3/36
63	381235	500	120	3/36
80	381240	500	120	3/36
100	381245	500	120	3/36
125	381250	500	120	3/36
160	381255	500	120	3/36



381255

<b>NH1</b>				
200	381260	500	120	3/36
224	381265	500	120	3/36
250	381270	500	120	3/36

<b>C2</b>				
	T-2			
63	381325	500	120	3/30
80	381330	500	120	3/30
100	381335	500	120	3/30
125	381340	500	120	3/30
160	381345	500	120	3/30
200	381350	500	120	3/30
224	381355	500	120	3/30
250	381360	500	120	3/30



381370

<b>NH2</b>				
315	381370	500	120	3/30
355	381375	500	120	3/30
400	381380	500	120	3/30

<b>C3</b>				
	T-3			
250	381435	500	120	3/24
315	381445	500	120	3/24
355	381450	500	120	3/24
400	381455	500	120	3/24



381455

<b>NH3</b>				
500	381465	500	120	3/24
630	381470	500	120	3/24

<b>NH4</b>				
	T-4			
315	376505	500	120	1/6
400	376510	500	120	1/6
500	376515	500	120	1/6
630	376520	500	120	1/6
800	376525	500	120	1/6
900	376527	500	120	1/6
1000	376530	500	120	1/6
1250	376535	500	120	1/6



376525

**F**

# fusibles

## CARTUCHOS FUSIBLES NH (APR) INDUSTRIALES

DIMENSIONES

gL/gG-aM

### DIMENSIONES

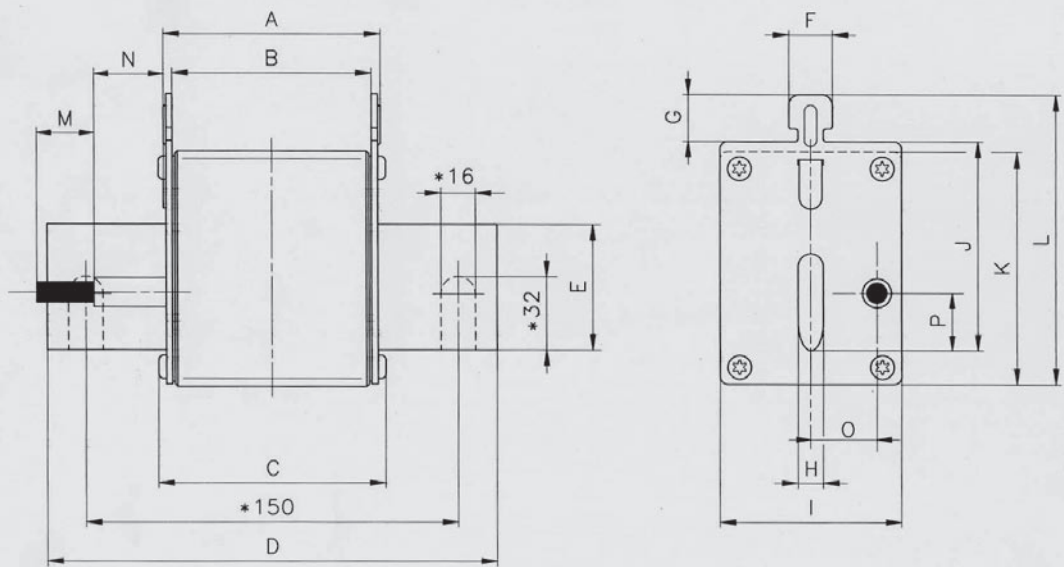

datos técnicos

(\*) Fusible NH4

CARTUCHOS FUSIBLES NH (APR) INDUSTRIALES

FUSIBLES NH gG 500V INDICADOR SUPERIOR

CARACTERÍSTICAS t-I

CARACTERÍSTICAS DE LIMITACION

gL/gG500V

CARACTERÍSTICAS t-I

NH000-NH00-NH0-NH1-NH2-NH3

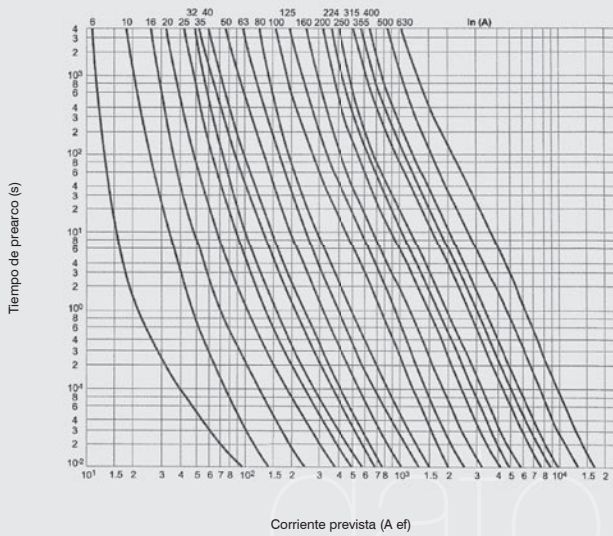

NH4

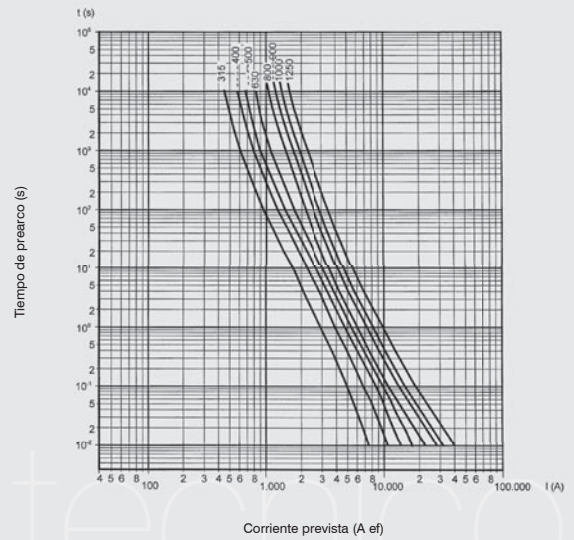

CARACTERÍSTICAS DE LIMITACION

NH000-NH00-NH0-NH1-NH2-NH3

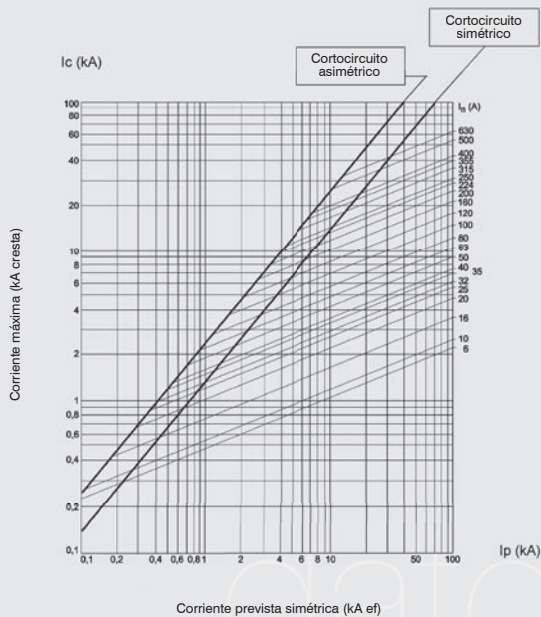

NH4

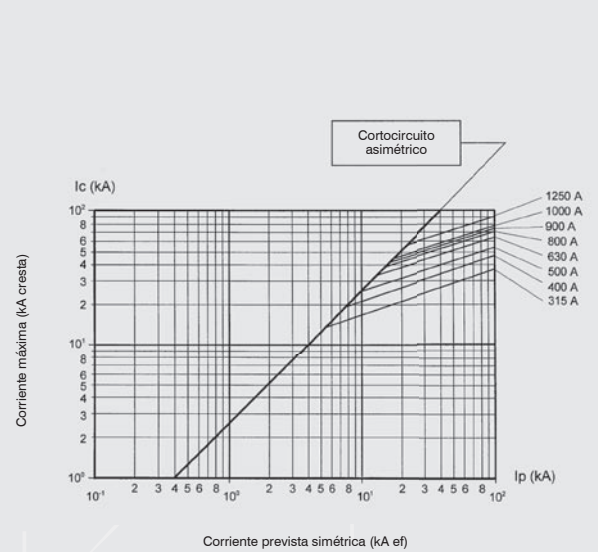

## CARTUCHOS FUSIBLES NH (APR) INDUSTRIALES

FUSIBLES NH gG 500V INDICADOR SUPERIOR

CARACTERÍSTICAS I<sup>2</sup>t  
POTENCIAS DISIPADAS

# gL/gG500V

### CARACTERÍSTICAS I<sup>2</sup>t NH4

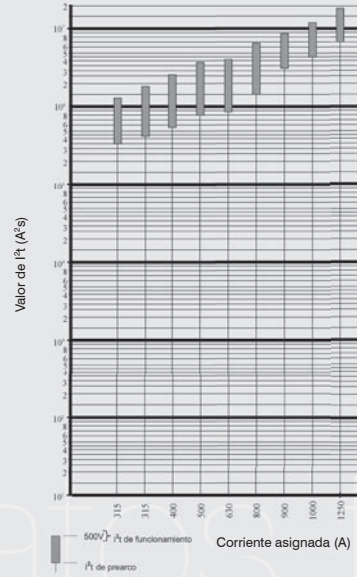

### POTENCIAS DISIPADAS

In (A)	TAMAÑO						
	NH000 (W)	NH00 (W)	NH0 (W)	NH1 (W)	NH2 (W)	NH3 (W)	NH4 (W)
2	0,7	—	—	—	—	—	—
4	1,7	—	—	—	—	—	—
6	1,4	—	1,8	—	—	—	—
10	1,1	—	1,4	—	—	—	—
16	1,7	—	2,2	—	—	—	—
20	1,8	—	2,3	—	—	—	—
25	2,2	—	2,9	—	—	—	—
32	3,2	—	4,5	—	—	—	—
35	2,9	—	3,9	—	—	—	—
40	3,5	—	5,1	—	—	—	—
50	3,5	—	4,5	4,5	—	—	—
63	4,6	—	6,1	6,1	5,9	—	—
80	5,6	—	6,9	6,9	6,7	—	—
100	7,1	—	8,5	8,5	8,2	—	—
125	—	7,8	9,6	9,6	9,3	—	—
160	—	10,9	12,8	12,8	12,5	—	—
200	—	—	—	15,9	15,9	—	—
224	—	—	—	18,4	18,4	—	—
250	—	—	—	20,4	20,4	20,2	—
315	—	—	—	—	25,0	25,0	26,1
355	—	—	—	—	29,5	29,5	—
400	—	—	—	—	33,5	33,5	32,7
425	—	—	—	—	—	36,9	—
500	—	—	—	—	—	40,6	37,0
630	—	—	—	—	—	47,0	47,0
800	—	—	—	—	—	—	68,0
900	—	—	—	—	—	—	76,0
1000	—	—	—	—	—	—	80,0
1250*	—	—	—	—	—	—	108,0

(\*) Fusibles sobrecalibrados